



Washing Machine OWNER'S MANUAL

WD-1060F(H)D/1065F(H)D

WD-1260F(H)D/1265F(H)D

WD-1460F(H)D/1465F(H)D

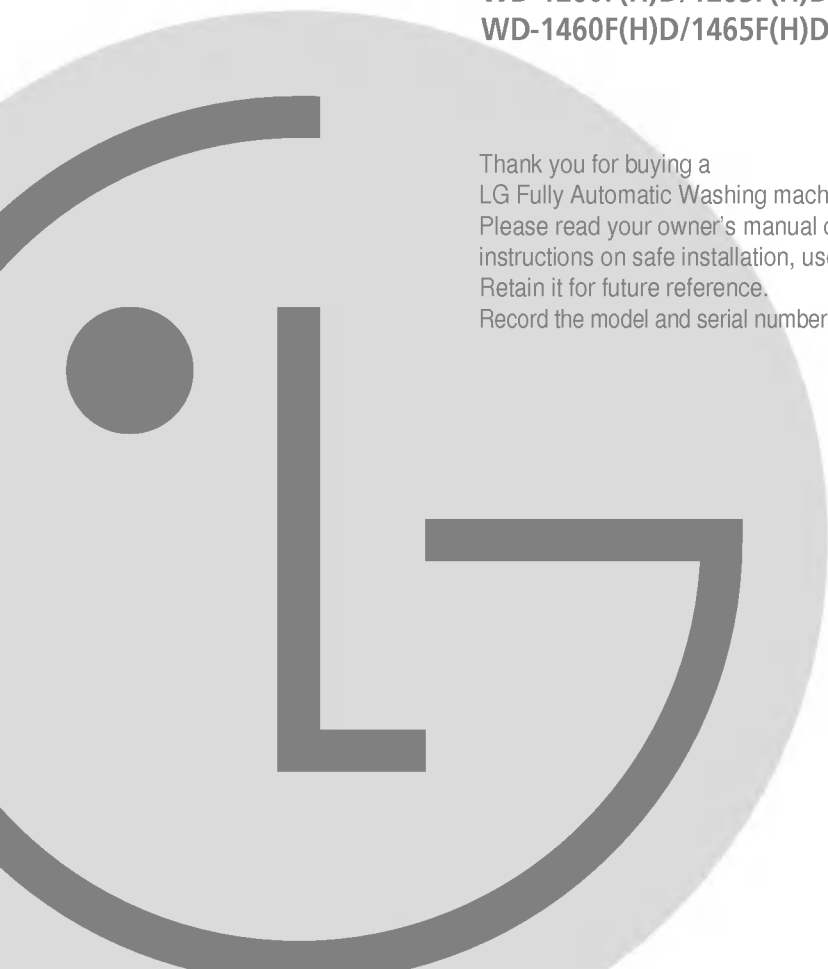
A large, light grey watermark of the LG logo is positioned in the lower-left and center of the page. It features a stylized 'L' and 'G' within a circular frame.

Thank you for buying a
LG Fully Automatic Washing machine.
Please read your owner's manual carefully, it provides
instructions on safe installation, use and maintenance.
Retain it for future reference.
Record the model and serial numbers of your washing machine.



■ **Jumbo drum**

LG's jumbo drum can wash about 40% more load than conventional washing machines. A bigger drum improves the wash performance.

■ **More economical by Intelligent Wash System**

Intelligent Wash System detects the amount of load and water temperature, and then determines the optimum water level and washing time to minimize energy and water consumption.

■ **Direct Drive System**

The advanced Brushless DC motor rotates the Drum directly without belt and pulley.

■ **Child-Lock**

The Child-Lock system has been used to prevent children from pressing any button to change the program during operation.

■ **Low noise speed control system**

By sensing the amount of load and balance, it evenly distributes load to minimize the spinning noise level.

■ **Auto Restart**

If the washing machine is turned off by a power failure, it will restart automatically from the position it stopped at adjusting accordingly.

Warnings.....3

Specification4

Installation.....5

Care before washing.....11

Adding detergent12

Function13

How to use washer14

Maintenance20

Troubleshooting guide23

READ ALL INSTRUCTIONS BEFORE USE



For your safety, the information in this manual must be followed to minimize the risk of fire or explosion, electric shock, or to prevent property damage, personal injury, or loss of life.

IMPORTANT SAFETY INSTRUCTIONS

WARNING : To reduce the risk of fire, electric shock, or injury to persons when using the washer, follow basic precautions, including the following:

- Do not install or store the washer where it will be exposed to the weather.
- Do not tamper with controls.
- Do not repair or replace any part of the washer or attempt any servicing unless specifically recommended in the user-maintenance instructions or published user-repair instructions that you understand and have the skills to carry out.
- Keep the area underneath and around your appliances free of combustible materials such as lint, paper, rags, chemicals, etc.
- The appliance is not intended for use by young children or infirm persons without supervision.
- Young children should be supervised to ensure that they do not play with the appliance.
- Do not leave the washer door open.
An open door could entice children to hang on the door or crawl inside the washer.
- Never reach into washer while it is moving. Wait until the drum has completely stopped.
- The laundry process can reduce the flame retardant of fabrics.
- Do not wash or dry articles that have been cleaned in, washed in, soaked in, or spotted with combustible or explosive substances (such as wax, oil, paint, gasoline, degreasers, dry-cleaning solvents, kerosene, etc.) which may ignite or explode.
- To avoid such a result, carefully follow the garment manufacturer's wash and care instructions.
- Do not slam the washer door closed or try to force the door open when locked. This could result in damage to the washer.
- To minimize the possibility of electric shock, unplug this appliance from the power supply or disconnect the washer at the household distribution panel by removing the fuse or switching off the circuit breaker before attempting any maintenance or cleaning.
- Never attempt to operate this appliance if it is damaged, malfunctioning, partially disassembled, or has missing or broken parts, including a damaged cord or plug.

SAVE THESE INSTRUCTIONS

GROUNDING INSTRUCTIONS

This appliance must be grounded. In the event of malfunction or breakdown, grounding will reduce the risk of electric shock by providing a path of least resistance for electric current. This appliance is equipped with a cord having an equipment-grounding conductor and grounding plug. The plug must be plugged into an appropriate outlet that is properly installed and grounded in accordance with all local codes and ordinance.

- Do not use an adapter or otherwise defeat the grounding plug.
- If you don't have the proper outlet, consult an electrician.

WARNING : Improper connection of the equipment-grounding conductor can result in risk of electric shock. Check with a qualified electrician or serviceman if you are in doubt as to whether the appliance is properly grounded. Do not modify the plug provided with the appliance - if it does not fit the outlet, have a proper outlet installed by a qualified electrician.



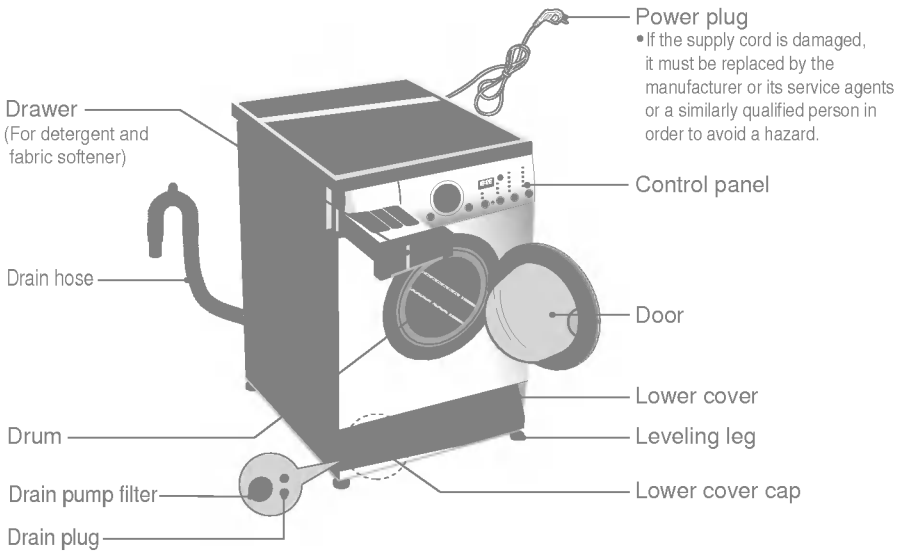

- Name : Front loading washing machine
- Power supply : 240V~, 50Hz
- Size : 600mm(W) × 600mm(D) × 850mm(H)
- Weight : 65kg
- Wash capacity : Refer to the Rating label
- Max. Watt : 2100W
- Spin speed : No Spin/400/600/800/1000[WD-1060F(H)D]
No Spin/400/800/1000/1200[WD-1260F(H)D/WD-1265F(H)D]
No Spin/400/800/1000/1400[WD-1460F(H)D/WD-1465F(H)D]
- Water consumption : 75 ℓ (10.7 ℓ / kg)
- Permissible water pressure : 0.3-10kgf/cm² (30-1000kPa)
- The hot water should ideally be 60°C and must NOT be above 70°C
- Permissible cold water temperature : 4-25°C
- TT : Appliance co.y with the requirement by certification Type Test Mark.
- No further backflow protection required for connection to the water supply.
- * The appearance and specifications may be varied without notice to raise the units quality.

■ Accessories

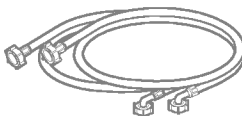

Inlet hose(1EA)

※ Option : Hot/Cold(2EA)



Spanner

Install or store where it will not be exposed to temperatures below freezing or exposed to the weather. Properly ground washer to conform with all governing codes and ordinances. The base opening must not be obstructed by carpeting when the washing machine is installed on a carpeted floor.

■ Transit bolts

The appliance is fitted with transit bolts to prevent internal damage during transport.

■ Removing transit bolts

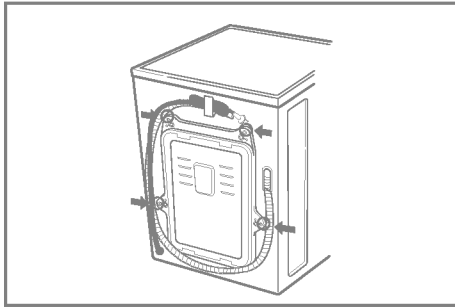

1. To prevent internal damage during transport, the special 4 bolts are locked. Before operating the washer, remove the bolts along with the rubber bungs.

- If they are not removed, it may cause heavy vibration, noise and malfunction.

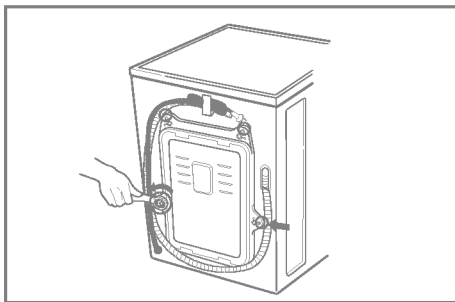

2. Unscrew the 4 bolts with the spanner supplied.

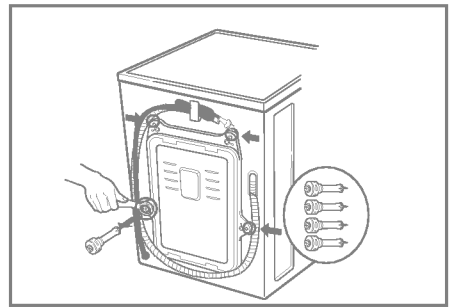

3. Take out the 4 bolts along with the rubber bungs by slightly twisting the bung. Keep the 4 bolts and the spanner for future use.

- Whenever the appliance is transported, the transit bolts must be refitted.

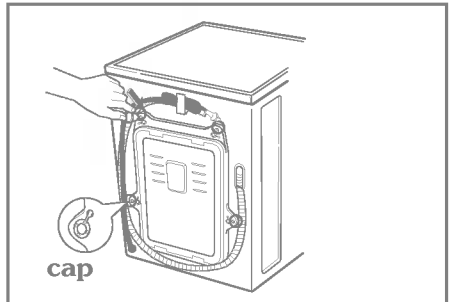

4. Close the holes with the caps supplied.



■ Installation place requirement

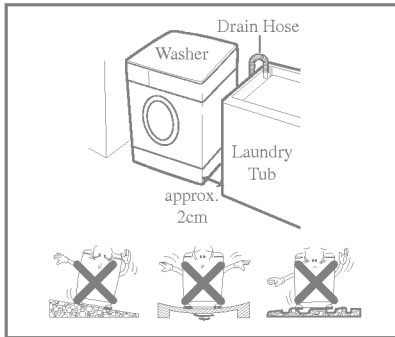

Level floor :

Allowable slope under entire washer is 1°

Power outlet :

Must be within 1.5 meters of either side of location of washer. Do not overload the outlet with more than one appliance.

Additional Clearance :

For wall, door and floor modeling is required.
(10cm : rear /2cm:right & left side)

Do not place or store laundry products on top of washer at any times.

They can damage the finish or controls.

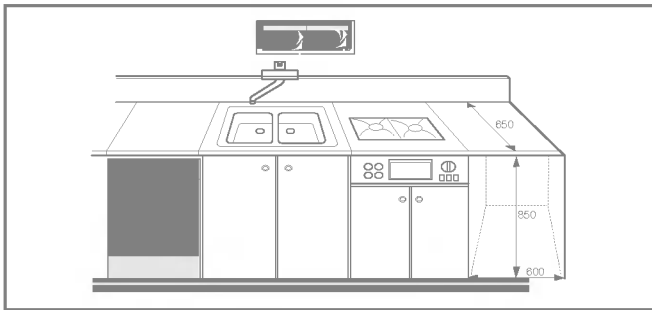

■ BS Plug Safety Details (For U.K. User)

IMPORTANT

THE WIRES IN THIS MAINS LEAD ARE COLOURED IN ACCORDANCE WITH THE FOLLOWING CODE:

GREEN AND YELLOW: EARTH

BLUE: NEUTRAL

BROWN: LIVE

This appliance must be earthed

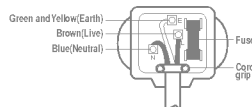

As the colours of the wires in the mains lead of this apparatus may not correspond with the coloured markings identifying the terminals in your plug, proceed as follows:

The wire which is coloured Green and Yellow must be connected to the terminal in the plug which is marked with the letter E or by the earth symbol ($\frac{\perp}{\text{—}}$) or coloured Green or Green and Yellow.

The wire which is coloured Blue must be connected to the terminal which is marked with the letter N or coloured Black.

The wire which is coloured Brown must be connected to the terminal which is marked with the letter L or coloured Red.

If a 13 amp (BS 1363) plug is used, fit a 13 amp BS 1362 fuse.

■ Electrical connection

1. Do not use an extension cord or double adapter.
2. If the appliance is supplied from a cord extension set or electrical portable outlet device the cord set or electrical portable outlet device should be positioned so it is not subject to splashing or ingress of moisture.
3. Always unplug the machine and turn off the water supply after use.
4. Connect the machine to an earthed socket in accordance with current wiring regulations.
5. The appliance must be positioned so that the plug is easily accessible.

■ Washing Machine is to be connected to the water mains using new hose-sets and that old hose-sets should not be used.

■ Connecting water supply hose

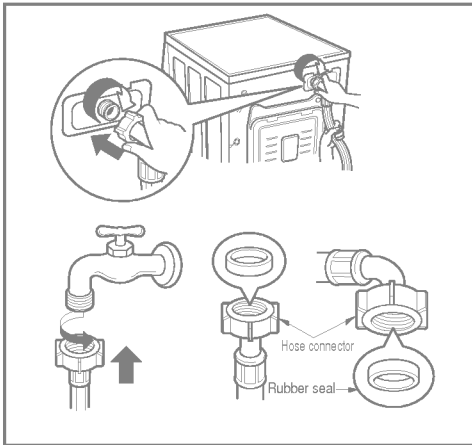

► *Water supply pressure must be between 30kPa and 1000kPa (0.3~10kg.f/cm²)*

► *Don't strip or crossthread when connecting Inlet hose to the valve.*

► *If the water supply pressure is more than 1000kPa, a decompression device should be installed.*

- Two rubber seals are supplied with the water inlet hoses these are in order to prevent water leaks.
- Check water tightness of washing machine connections by turning the tap completely on.
- Periodically check the condition of the hose and replace the hose if necessary.
- Make sure that there is no kink on the hose and that it is not crushed.

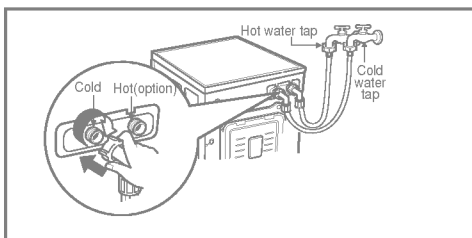

► *When your washer has two valve,*

- The Inlet hose which has red connector is for the hot water tap.
- If the washer has two valves, the energy is saved by using hot valve.



■ Normal Tap without thread & screw type inlet hose

1. Unscrew the fixing screw to attach the tap.

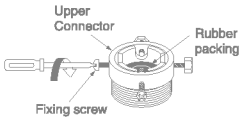

2. Push the connector up till the rubber packing is in tight contact with the tap. Then tighten the 4 screws.

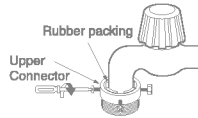

3. Push the water supply hose vertically upwards so that the rubber packing within in the hose can adhere completely to the tap and then tighten it by screwing it to the right.

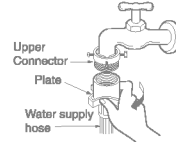

■ Normal Tap without thread & one touch type inlet hose

1. Untighten the upper connector screw.

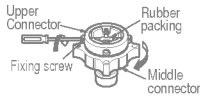

2. Push the upper connector up till the rubber packing is in tight contact with the tap. Then tighten the 4 screws.

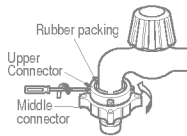

3. Connect the water supply hose to the middle connector, pushing the plate down.

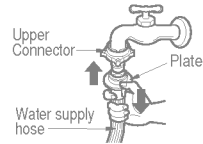

• In case the diameter of the tap is large remove the guide plate.

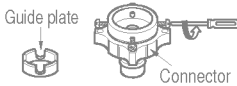

- Turn the middle connector not to have water leaked.
- Make sure that the rubber seal is inside the hose connector.

- To separate the water supply hose from the middle connector shut off the tap. Then pull the inlet hose down, pushing the plate down.

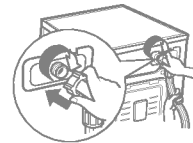
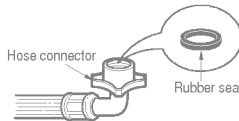

- Your machine comes with only cold water connection.
- Make sure that there are no kinks in the hose and that it is not crushed.

Used the horizontal tap

Horizontal tap



Extension tap



Square tap



■ Installation of drain hose

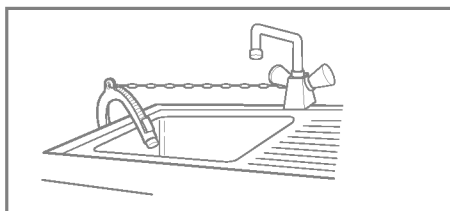
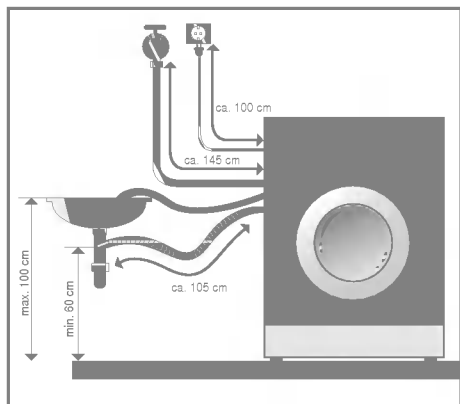

- When installing the drain hose sink, secure it tightly with a string.
- Proper securing the drain hose will protect the floor from damage due to water leakage.

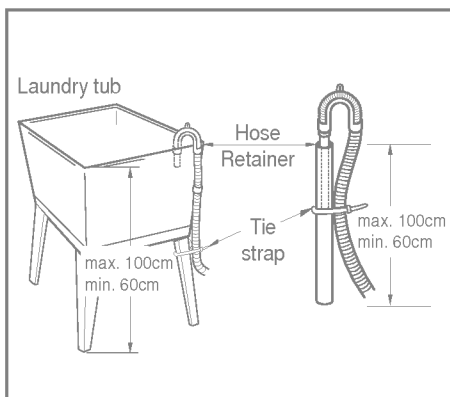
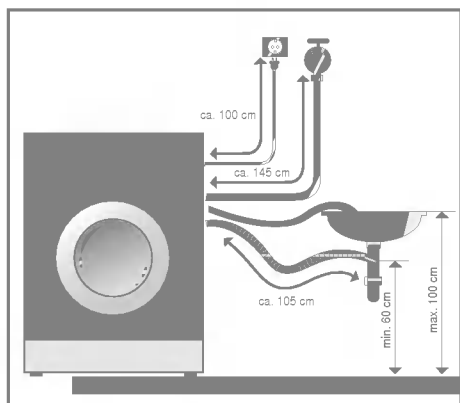

- The drain hose should not be placed higher than 100 cm above the floor.
- Proper securing the drain hose will protect the floor from damage due to water leakage.
- When the drain hose is too long, please don't fill into the washer. This will cause abnormal noise.

- When installing the drain hose sink, secure it tightly with a string.
- Proper securing the drain hose will protect the floor from damage due to water leakage.



■ Level adjustment

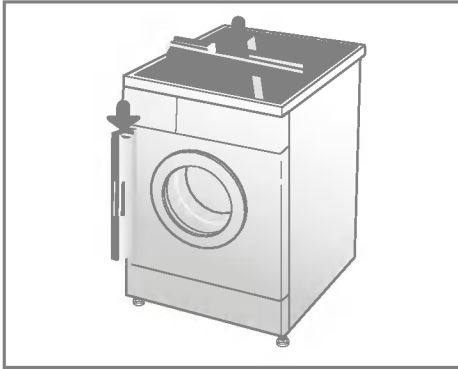

1. Leveling a the washing machine properly prevents excessive noise and vibration. Install the appliance on a solid and level floor surface, preferably in a corner of the room.

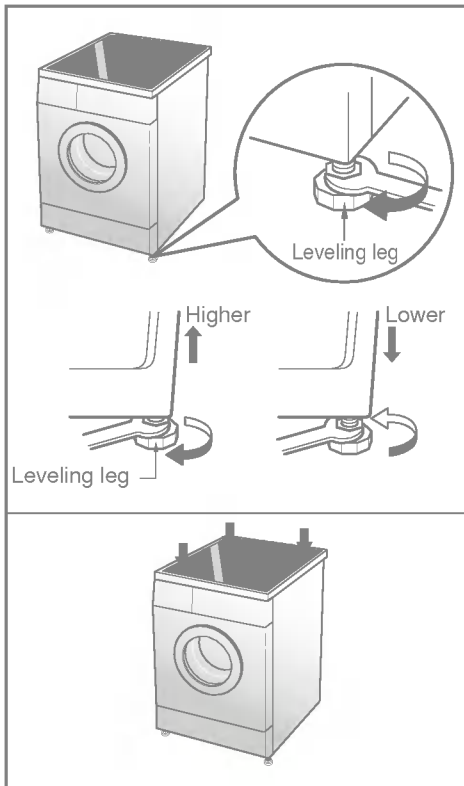

2. If the floor is uneven, adjust the leveling feet as required. (do not insert pieces of wood etc. under the feet)
Make sure that all four feet are stable and resting on the floor and then check that the appliance is perfectly level. (use a spirit level)

* Diagonal Check

*When pushing down the edges of the washing machine top plate diagonally, the machine should not move up and down at all. (Please, check both of two directions)
If machine rocks when pushing the machine top plate diagonally, adjust the legs again.*

■ Caring before washing

1. Care Labels

Look for a care label on your clothes. This will tell you about the fabric content of your garment and how it should be washed.

2. Sorting

To get the best results, Sort clothes into loads that can be washed with the same wash cycle. Water temperature and spin speed and different fabrics need to be washed in different ways. Always sort dark colors from pale colors and whites. Wash separately as dye and lint transfer can occur causing discoloration of white etc. If possible, do not wash heavily soiled items with lightly soiled one.

Soil (Heavy, Normal, Light)
Color (White, Lights, Darks)
Lint (Lint producers, Collectors)

Separate clothes according to amount of soil.
Separate white fabrics from colored fabrics.
Wash lint producers and lint collectors separately.

3. Caring before loading

- **Combine large and small items in a load. Load large items first. Large items should not be more than half the total wash load.**
Do not wash single items. This may cause an out-of-balance load. Add one or two similar items.

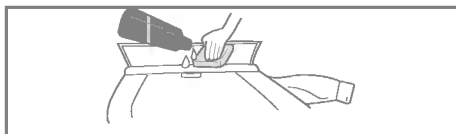
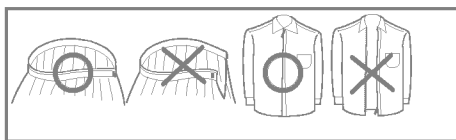
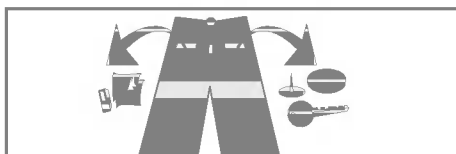

- Check all the pockets to make sure that they are empty. Things such as nails, hair clip, matches, pens, coins and keys can damage both your washer and your clothes.
- Close zippers, hook and strings to make sure that these items don't snag on other clothes.
- Pre treat dirt and stains by brushing a little detergent dissolved in water onto stains like collars and cuffs to help shift dirt.



■ Adding detergent and fabric softener

1. The Dispenser Drawer

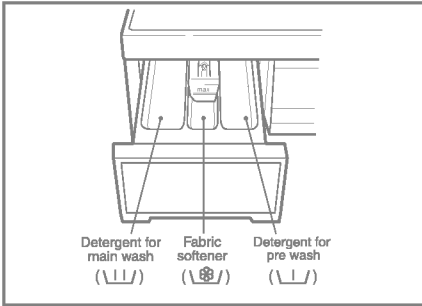

- Main wash only U 
- Pre Wash + Main Wash U 

2. Adding Fabric Softener

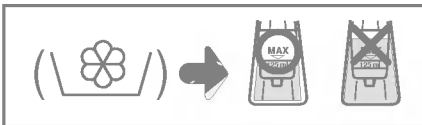

- Do not exceed the maximum fill line. Overfilling can cause early dispensing of the fabric softener which could stain clothes.
- Do not leave the fabric softener in the detergent drawer for more than 2 days. (Fabric softener could harden)
- Softener will automatically be added during last rinse cycle.
- Do not open the drawer when water is supplied.
- Solvents (benzene, etc) are not allowable.

 Do not pour fabric softener directly on the cloths

3. Detergent dosage

- The detergent should be used according to the instruction of the detergent manufacture.
- If too much detergent is used more than the recommended amount, too many suds can occur and this will decrease the washing result or cause heavy load to the motor. (Causing a malfunction)
- Use powder detergent only for the front loading washer.
- Detergent usage may need to be adjusted for water temperature, water hardness, size and soil level of the load. For best results, avoid oversudsing.

* Tips

Full load : according to manufacturer's recommendation.
Part load : 3/4 of the normal amount.
Minimum load : 1/2 of full load.

- Detergent is flushed from the dispenser at the beginning of the cycle.

■ Recommended courses according to the laundry type

Program	Fabric Type	Proper Temp. (Option)	Washing (Option)	Maximum Load	Water in Liter	Energy in kWh	Time in Minutes
Coloureds	Color fast garments (shirts, night dresses, pajamas...) and lightly soiled white cotton (underwear...)	40°C (Cold, 30°C, 60°C)	Main(+Pre)	Rating	75	0.47	119
Synthetic	Polyamide, Acrylic, Polyester	40°C (Cold, 30°C, 60°C)	Main(+Pre)	Less than 4.0 kg	55	0.39	92
Delicate	Delicate laundry easily damaged (silk, curtains...)	Cold (30°C, 40°C)	Main	Less than 3.0 kg	55	0.15	65
Wool	Machine washable woolens with pure new wool only	Cold (30°C, 40°C)	Main	Less than 2.0 kg	55	0.05	55
Rapid	Laundry type is the same in Coloureds and Synthetic.	Cold (30°C, 40°C)	Main	Rating	55	0.10	54
Whites	First check if laundry is machine washable. (white cotton, linen towels and sheets...)	95°C (40°C, 60°C)	Main(+Pre)	Rating	90	2.74	162
Whites-Eco	Laundry type is the same in Whites.	60°C (40°C)	Main(+Pre)	Rating	70	1.13	178

* Pre Wash : For heavily soiled and protein-stained items.

* Water Temperature : Select the water temperature to the wash cycles. Always follow garment manufacture's care label or instructions when laundering.



How to use washer



1. For use in the initial programme (Coloureds)

- To start push the **Power** button.
- Push the **Start/Pause** button.
- Initial condition
 - *Wash : Only main wash*
 - *Rinse : 3 times*
 - *Spin : 800 rpm*
 - *Water temperature : 40°C*
 - *Program : Coloureds*

2. Manual Selecting

- To start push the **Power** button.
- Select the conditions which you want to use, by pressing each button.

For selecting the each conditions, please refer to the page15~page19

- Push the **Start/Pause** button.

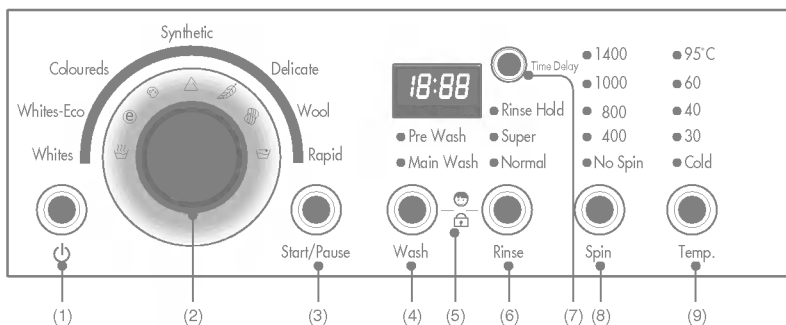

- | | | |
|--------------------------|--------------------|--------------------------|
| (1) Button : Power | (4) Button : Wash | (7) Button : Time Delay |
| (2) Dial : Programme | (5) Child lock | (8) Button : Spin |
| (3) Button : Start/Pause | (6) Button : Rinse | (9) Button : Water Temp. |



1. Power

- Press the Power button to turn power on and off
- To cancel the **Time Delay** function, it can also be used.

2. Initial Program

- When the Power button is pushed, the washer is ready for Coloureds program. And the other initial conditions as follows.
- So, if you want to advance into the washing cycle without selecting the program, just push **Start/Pause** button and then the washer will proceed.

Initial program

- Coloureds Program / Main wash / Normal Rinse/800 rpm / 40°C

- 7 programs are available according to the laundry type.

- Coloureds
- Synthetic
- Delicate
- Wool
- Rapid
- Whites
- Whites-Eco

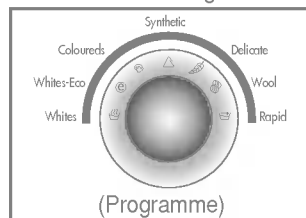

1. Program

- When **Start/Pause** button is pushed, Coloureds program is automatically selected.
- By turning the Program dial, the program is selected in orders of "Coloureds ∪ Synthetic ∪ Delicate ∪ Wool ∪ Rapid ∪ Whites ∪ Whites-Eco".

Regarding to the laundry type for each program Please refer to the page13.

2. Course

- | | |
|--------------|------------|
| - Whites | - Delicate |
| - Whites-Eco | - Wool |
| - Coloureds | - Rapid |
| - Synthetic | |





Start/Pause

1. Start

- This **Start/Pause** button is used to start wash cycle or pause the cycles.

2. Pause

- If temporary stop of wash cycle is needed, push "**Start/Pause**" button.
- After the pause button is pressed, the power is turned off automatically 4 minutes later.

- Pre Wash
- Main Wash



Wash

- By pressing the Wash button, the wash type can be selected.

- *Main Wash*
- *Pre + Main Wash*

1. Main Wash

- Main Wash course is available for lightly or normally soiled laundry.

2. Pre + Main Wash

- If the laundry is heavily soiled, "*Pre + Main Wash*" course is effective.
- Pre Wash is available in *Coloureds*, *Whites*, *Whites-Eco* and *Synthetic* program.

If lamp turns on, that function has been selected.



Wash

Rinse

If you want to lock all the buttons to prevent operation by a child or infirm persons, this function can be used.

1. Child lock

- Child lock can be set by pressing and holding the **Wash** button and **Rinse** button simultaneously.

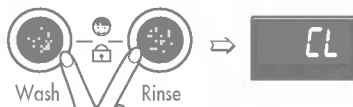

- *When child lock is set, all buttons are inoperable.*
- To deactivate Child lock system, press and hold **Wash** and **Rinse** button simultaneously again.



- If you want to change the program when Child lock is active,
 1. Press and hold both **Wash** and **Rinse** together.
 2. Press the **Start/Pause** button.
 3. Change the desired program and press the **Start/Pause** button.



- The child lock can be set at any time and it is automatically canceled when operational errors occur. Also *Child lock* works when power is off.

- Rinse Hold
- Super
- Normal



Rinse

• By pressing the Rinse button, the Rinse type can be selected.

- Normal
- Super
- Normal + Rinse Hold
- Super + Rinse Hold

1. Normal

- *Coloureds / Whites / Whites-Eco / Synthetic performs 3 Rinses*
- *Rapid / Wool / Delicate performs 2 Rinses*

2. Super

- Normal + 1 more rinse time.
- Use the Super rinse when additional rinsing is desired to remove excess dirt and detergent soiled loads.

3. Rinse Hold

- If you desire to leave fabrics in the machine without spinning after rinse to prevent them from getting wrinkled, you may select rinse hold by pressing the Rinse button.
To drain and spin, press the Rinse button or Start/Pause button to turn off the rinse hold lamp.

If lamp turns on, that function has been selected.



1. Time Delay

Preparing washing before starting “Time Delay”

- Turn on the water tap.
- Load laundry and close the door.
- Place the detergent and fabric softener in the drawer.

- How to set “Time Delay”
 - Push **Power** button.
 - Turn the **Programme** dial to select the program you require.
 - Push **Time Delay** button and set the desired time.
 - Push the **Start/Pause** button. (“:” blinks.)

- If **Time Delay** button is pushed, “3:00” is displayed. The maximum delayed time is 19:00 hours and the minimum time is 3:00 hours.

- Each pushing of the button advances time delay by one hour.

- To cancel the time delay, push the **Power** button.

- **Time Delay** is ‘expected time’ from the present to the completion of washing cycle or selected process (Wash, Rinse, Spin).

- *According to the condition of water supply and temperature, the delayed time and the actual washing time may vary.*



- 1000
- 800
- 600
- 400
- No Spin



Spin

- 1200
- 1000
- 800
- 400
- No Spin



Spin

- 1400
- 1000
- 800
- 400
- No Spin



Spin

[WD-1060F(H)D]

[WD-1260F(H)D/
1265F(H)D]

[WD-1460F(H)D/
1465F(H)D]

• By pushing the Spin button, the spin rpm can be chosen.

[WD-1060F(H)D]

[WD-1260F(H)D/
1265F(H)D]

[WD-1460F(H)D/
1465F(H)D]

- No Spin

- No Spin

- No Spin

- 400

- 400

- 400

- 600

- 800

- 800

- 800

- 1000

- 1000

- 1000

- 1200

- 1400

1. Spin selection

• Spin rpm is available according to the program as follows.

- Coloureds

800 ∪ 1000 ∪ (1200) ∪ (1400) ∪ No Spin ∪ 400 ∪ (600)

- Whites/Whites-Eco

800 ∪ 1000 ∪ (1200) ∪ (1400) ∪ No Spin ∪ 400 ∪ (600)

- Rapid

800 ∪ 1000 ∪ (1200) ∪ (1400) ∪ No Spin ∪ 400 ∪ (600)

- Synthetic

800 ∪ 1000 ∪ No Spin ∪ 400 ∪ (600)

- Delicate

400 ∪ No Spin ∪ 600 ∪ 800 [WD-1060F(H)D]

400 ∪ No Spin ∪ 800

[WD-1260F(H)D/1265F(H)D/1460F(H)D/1465F(H)D]

- Wool

400 ∪ No Spin ∪ (600) ∪ 800 ∪ 1000

2. No spin

• If no spin is selected, the washer stops after draining water.

If lamp turns on, that function has been selected.

- 95°C
- 60
- 40
- 30
- Cold



Temp.

• By pushing the Temp button, the water temperature can be selected.

- Cold

- 30°C / 40°C / 60°C / 95°C

1. Water Temperature

• Water temperature can be selected as below according to the program.

- Coloureds & Synthetic

40°C ∪ 60°C ∪ Cold ∪ 30°C

- Whites

95°C ∪ 40°C ∪ 60°C

- Whites-Eco

60°C ∪ 40°C

- Rapid & Wool & Delicate

Cold ∪ 30°C ∪ 40°C

Selected temperature's lamp turns on.

For the more detailed information, please refer to the page 13.



1. Special function display

- When child lock is selected, the “**CL**” is displayed.
- When time delay is selected, it shows the remaining times to finish the selected program.

2. Self diagnose display

- If the washer has a trouble, the trouble type is displayed.

“**PE**” : Sensing water pressure error

“**FE**” : Problem of overfilling water

“**dE**” : Door is not closed

“**LE**” : Over load in motor

“**CE**” : Over load in motor

“**IE**” : Water inlet trouble

“**DE**” : Drainage trouble

“**UE**” : Imbalance trouble

“**EE**” : Water temperature trouble

If this error letters are displayed, please refer to the troubleshooting page23 and follow the guide.

3. Completion of washing

- When washing cycle is completed, “**End**” is displayed on the “*Multi display*”.

4. Time left

- During washing cycle, the remaining washing time is displayed.
- Recommended program by manufacturer.
 - Coloureds : around 1 hour and 59 minutes
 - Synthetic : around 1 hour and 32 minutes
 - Delicate : around 1 hour and 5 minutes
 - Wool : around 55 minutes
 - Rapid : around 54 minutes
 - Whites : around 2 hours and 42 minutes
 - Whites-Eco : around 2 hours and 58 minutes
- The washing time may vary by the amount of laundry, water pressure, water temperature and other washing conditions.
- If the imbalance is detected or if the suds removing program works, the wash time shall be longer. (Max. increasing time is 45minutes.)



aintenance

* Before cleaning the washer interior, unplug the electrical power cord to avoid electrical shock to avoid electrical shock hazards.

■ The water inlet filter

- " iE " error message will blink on the control panel when water does not enter the detergent drawer.

- If your water is very hard or contains traces of lime deposit, the water inlet filter may become clogged.

It is therefore a good idea to clean it from time to time.

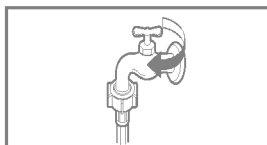

1. Turn off the water tap.



2. Unscrew the water inlet hose.

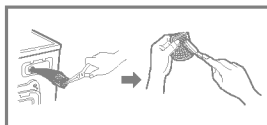

3. Clean the filter using a hard bristle brush.

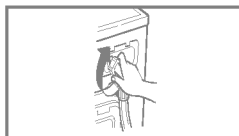

4. Tighten up the inlet hose.

■ The drain pump filter

* The drain filter collects threads and small objects left in the laundry.

Check regularly that the filter is clean to ensure smooth running of your machine.

▲ **CAUTION** First drain it using the drain hose and then open the pump filter to remove whatever may have stopped it up.
Be careful when draining if the water is hot.

1. Open the lower cover cap (①) by using coin. Turn the drain plug (②) to pull out the hose.

2. Unplug the drain plug (②), allowing the water to flow out. At this time use a vessel to prevent water flowing on to the floor. If the water does not flow any more, turn the pump filter (③) open to the left.

3. Take out any foreign material from the pump filter (③). After cleaning, turn the pump filter (③) clockwise and insert the drain plug (②) to the original place. close the lower cover cap.

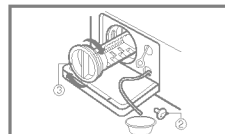
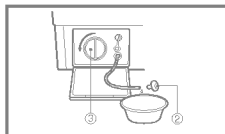
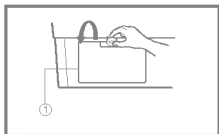

aintenance

■ Dispenser drawer

- * After a while detergents and fabric softeners leave a deposit in the drawer.
- It should be cleaned from time to time with a jet of running water.
- If necessary it can be removed completely from the machine by pressing the catch downward and by pulling it out.
- To facilitate cleaning, the upper part of the fabric softener compartment can be removed.

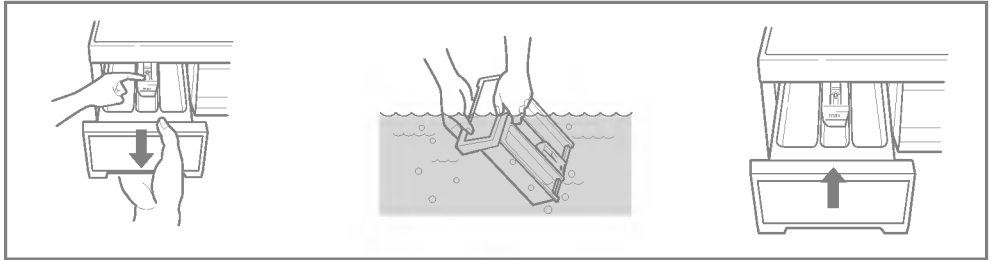

■ The drawer recess

- * Detergent can also accumulate inside the recess which should be cleaned occasionally with an old toothbrush.
- Once you have finished cleaning, replace the drawer and run a rinse cycle without laundry.

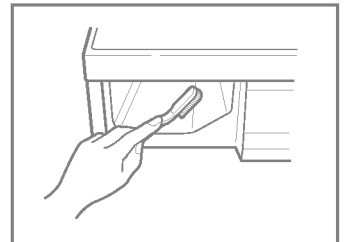

■ The washing drum

- If you live in a hard water area, limescale continuously builds up in places where it cannot be seen and it is not easily removed. Over time the build up of scale clogs appliances, and if it is not kept in check these will eventually have to be replaced.
- Although the washing drum is made of Stainless steel, specks of rust can be caused by small metal articles (paper clips, safety pins) which have been left in the drum.
- The washing drum should be cleaned from time to time.
- If you use descaling agents, dyes or bleaches, make sure they are suitable for washing machine use.
- * Descaler could contain components that can attack part of your washing machine.
- * Remove the spots with a stainless steel cleaning agent.
- * Never use steel wool.



aintenance

■ Cleaning your washer

1. Exterior

Proper care of your washer can extend its life.

The outside of the machine can be cleaned with warm water and a neutral non abrasive household detergent.

Immediately wipe off any spills. Wipe with damp cloth.

Try not to hit surface with sharp objects.

* IMPORTANT: Do not use methylated spirit, diluents or similar products.

2. Interior

Dry around the washer door opening, flexible gasket and door glass. These areas should always be clean to ensure a water tight seal.

Run washer through a complete cycle using hot water.

Repeat process if necessary.

 Remove hard water deposits using only cleaners labeled as washer safe.

■ Winterizing instructions

If the washer is stored in an area where freezing can occur or moved in freezing temperatures, follow these winterizing instructions to prevent damage to the washer:

1. Turn off water supply tap.
2. Disconnect hoses from water supply and drain water from hoses.
3. Plug electrical cord into a properly grounded electrical outlet.
4. Add 1gallon(3.8L) nontoxic recreational vehicle(RV) antifreeze to empty wash drum. Close door.
5. Set spin cycle and let washer spin for 1minute to drain out all water.
Not all of the RV antifreeze will be expelled.
6. Unplug electrical power cord, dry drum interior, and close door.
7. Remove dispenser drawer. Drain any water in compartments and dry compartments.
Replace drawer.
8. Store washer in an upright position.
9. To remove antifreeze from washer after storage, run empty washer through a complete cycle using detergent. Do not add wash load.

troubleshooting guide

* This washing machine is equipped with automatic safety functions which detect and diagnose faults at an early stage and react appropriately

When the machine does not function properly or does not function at all, check the following points before you call the Service Department.

Symptom	Possible Cause	Solution
Rattling and clanking noise	<ul style="list-style-type: none"> Foreign objects such as coins or safety pins maybe in drum or pump. 	<p>Stop washer and check drum and drain filter.</p> <p>If noise continues after washer is restarted, call your authorized service.</p>
Thumping sound	<ul style="list-style-type: none"> Heavy wash loads may produce a thumping sound. This is usually normal. 	<p>If sound continues, washer is probably out of balance. Stop and redistribute wash load.</p>
Vibrating noise	<ul style="list-style-type: none"> Have all the transit bolts and packing been removed? Are all the feet resting firmly on the ground? 	<p>If not removed during installation. See Installation for removing transit bolts.</p> <p>Wash load unevenly distributed in drum. Stop washer and rearrange wash load.</p>
Water leaks.	<ul style="list-style-type: none"> Fill hose connection is loose at tap or washer. House drain pipes are clogged. 	<p>Check and tighten hose connections.</p> <p>Unclog drain pipe. Contact plumber if necessary.</p>
Oversudsing		<p>Too much detergent or unsuitable detergent? The formation of foam can cause water leaks.</p>
Water does not enter washer or it enters slowly	<ul style="list-style-type: none"> Water supply it not adequate in area. Water supply tap is not completely open. Water inlet hose are kinked. The filter of the inlet hose clogged. 	<p>Check another tap in the house.</p> <p>Fully open tap.</p> <p>Straighten hose.</p> <p>Check the filter of the inlet hose.</p>
Water in the washer does not drain or drains slowly.	<ul style="list-style-type: none"> Drain hose is kinked or clogged. The drain filter is clogged. 	<p>Clean and straighten the drain hose.</p> <p>Clean the drain filter.</p>



troubleshooting guide

Symptom	Possible Cause	Solution
Washer does not start	<ul style="list-style-type: none">• Electrical power cord may not be plugged in or connection may be loose.• House fuse blown, circuit breaker tripped, or a power outage has occurred.• Water supply tap is not turned on.	<p>Make sure plug fits tightly in wall outlet.</p> <p>Reset circuit breaker or replace fuse. Do not increase fuse capacity. If problem is a circuit overload, have it corrected by a qualified electrician.</p> <p>Turn on water supply tap.</p>
Washer won't spin	<ul style="list-style-type: none">* Check that the door is firmly shut.	<p>Close the door and press the Start/Pause button. After pressing the Start/Pause button, it may take a few moments before the clothes washer begins to spin. The door must lock before spin can be achieved.</p>
Door does not open		<p>Once started, the door can not be opened for safety reasons.</p> <p>Wait one or two minutes before opening the door to give the electric locking mechanism time to release.</p>
Wash cycle time delayed		<p>The washing time may vary by the amount of laundry, water pressure, water temperature and other using conditions.</p> <p>If the imbalance is detected or if the suds removing program works, the wash time shall be increased.</p>

troubleshooting guide

Symptom	Possible Cause	Solution
IE	<ul style="list-style-type: none"> • Water supply it not adequate in area • Water supply taps are not completely open. • Water inlet hose are kinked. • The filter of the inlet hose clogged. 	Check another tap in the house. Fully open tap. Straighten hose. Check the filter of the inlet hose.
DE	<ul style="list-style-type: none"> • Drain hose is kinked or clogged. • The drain filter is clogged. 	Clean and straighten the drain hose. Clean the drain filter.
UE	<ul style="list-style-type: none"> • Load is too small. • Load is out of balance. • The appliance has an imbalance detection and correction system. If individual heavy articles are loaded bath mat, both robe, etc. this system may stop spinning or even interrupt the spin cycle altogether, if the imbalance is too great even after several spin starts. • If the laundry is still too wet at the end of the cycle, add smaller articles of laundry to balance the load and repeat the spin cycle. 	Add 1 or 2 similar items to help balance the load. Rearrange load to allow proper spinning
dE	 <ul style="list-style-type: none"> • Is the door opened? 	Close the door. * If "dE" is not released, call for service.
LE		Unplug the power plug and call for service.
FE	<ul style="list-style-type: none"> • If the water overfills due to the faulty water valve, you will get "FE" display. 	Close the water tap. Unplug the power plug. Call for service.
PE	<ul style="list-style-type: none"> • "PE" is displayed if the water level sensor malfunction. 	
CE	<ul style="list-style-type: none"> • Over load in motor. 	
LE	<ul style="list-style-type: none"> • Over load in motor. 	









LG Electronics Inc.