



LG Electronics Inc.



Owner's Manual

Washing Machine

WD-1219BD
WD-1019BD

Please read this manual carefully. It provides instructions on safe installation, use, and maintenance. Retain it for future reference.

Record the model and serial numbers of your machine and report this information to your dealer if your machine requires service.



Direct Drive System
The advanced Brushless DC motor directly drives the drum without belt and pulley.



Tilted Drum and Extra Large Door Opening
Tilted drum and extra large opening make it possible to load and unload clothing more easily.



Water Circulation
Spray detergent solution and water onto the load over and over. Clothes are soaked more quickly and thoroughly during wash cycle. The detergent suds can be removed more easily by the water shower during rinse cycle. The water circulation system uses both water and detergent more efficiently.

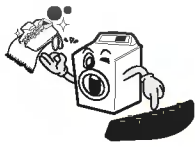

RollerJets
Washing ball enhances the wash performance and reduces damage to the clothing. The jets spray and help tumble clothes to enhance washing performance while maintaining fabric care.



Built-in Heater
Internal heater automatically heats the water to the best temperature on selected cycles.



Child Lock
The Child lock prevents children from pressing any button to change the settings during operation. The Power button will remain operative when the Child Lock is activated during a cycle.

Important Safety Information	3
Specifications	4
Installation Instructions	5
Preparation Before Washing	10
Using the Dispenser	11
Cycles	13
How to Use the Washer	14
Maintenance	20
Troubleshooting Guide	23
Warranty	26

READ ALL INSTRUCTIONS BEFORE USE

WARNING!

For your safety, the information in this manual must be followed to minimize the risk of fire or explosion, electric shock, or to prevent property damage, personal injury, or loss of life.

IMPORTANT SAFETY INSTRUCTIONS

WARNING: To reduce the risk of fire, electric shock, or injury to persons when using the washer, follow basic precautions, including the following:

- *Read all instructions before using the washer.*
- *Do not wash articles that have been previously cleaned in, washed in, soaked in, or spotted with gasoline, dry cleaning solvents, or other flammable or explosive substances, as they give off vapors that could ignite or explode.*
- *Do not add gasoline, dry cleaning solvents, or other flammable or explosive substances to the wash water. These substances give off vapors that could ignite or explode.*
- *Under certain conditions, hydrogen gas may be produced in a hot water system that has not been used for 2 weeks or more. **HYDROGEN GAS IS EXPLOSIVE.** If the hot water system has not been used for such a period, before using the washing machine, turn on all hot water faucets and let the water flow from each for several minutes. This will release any accumulated hydrogen gas. As the gas is flammable, do not smoke or use an open flame during this time.*
- *Do not allow children to play on or in the washer. Close supervision of children is necessary when the washer is used near children.*
- *Before the washer is removed from service or discarded, remove the door to prevent children from hiding inside.*
- *Do not install or store the washer where it will be exposed to the weather.*
- *Do not tamper with controls.*
- *Do not repair or replace any part of the washer or attempt any servicing unless specifically recommended in the user-maintenance instructions or published user-repair instructions that you understand and have the skills to carry out.*
- *See Installation Instructions for grounding requirements.*
- *ALWAYS follow the fabric care instructions supplied by the garment manufacturer.*
- *Do not place items exposed to cooking oil in your washer. Items contaminated with cooking oils may contribute to a chemical reaction that could cause a load to catch fire.*
- *Do not use fabric softeners or products to eliminate static unless recommended by the manufacturer of the fabric softener or product.*

SAVE THESE INSTRUCTIONS

GROUNDING INSTRUCTIONS

This appliance must be grounded. In the event of malfunction or breakdown, grounding will reduce the risk of electric shock by providing a path of least resistance for electric current. This appliance is equipped with a cord having an equipment-grounding conductor and grounding plug. The plug must be plugged into an appropriate outlet that is properly installed and grounded in accordance with all local codes and ordinance.

- *Do not use an adapter or extension cord.*
- *Do not remove ground prong.*
- *If you don't have the proper outlet, consult an electrician.*

WARNING: Improper connection of the equipment-grounding conductor can result in risk of electric shock.

Check with a qualified electrician or serviceman if you are in doubt as to whether the appliance is properly grounded. Do not modify the plug provided with the appliance - if it does not fit the outlet, have a proper outlet installed by a qualified electrician.

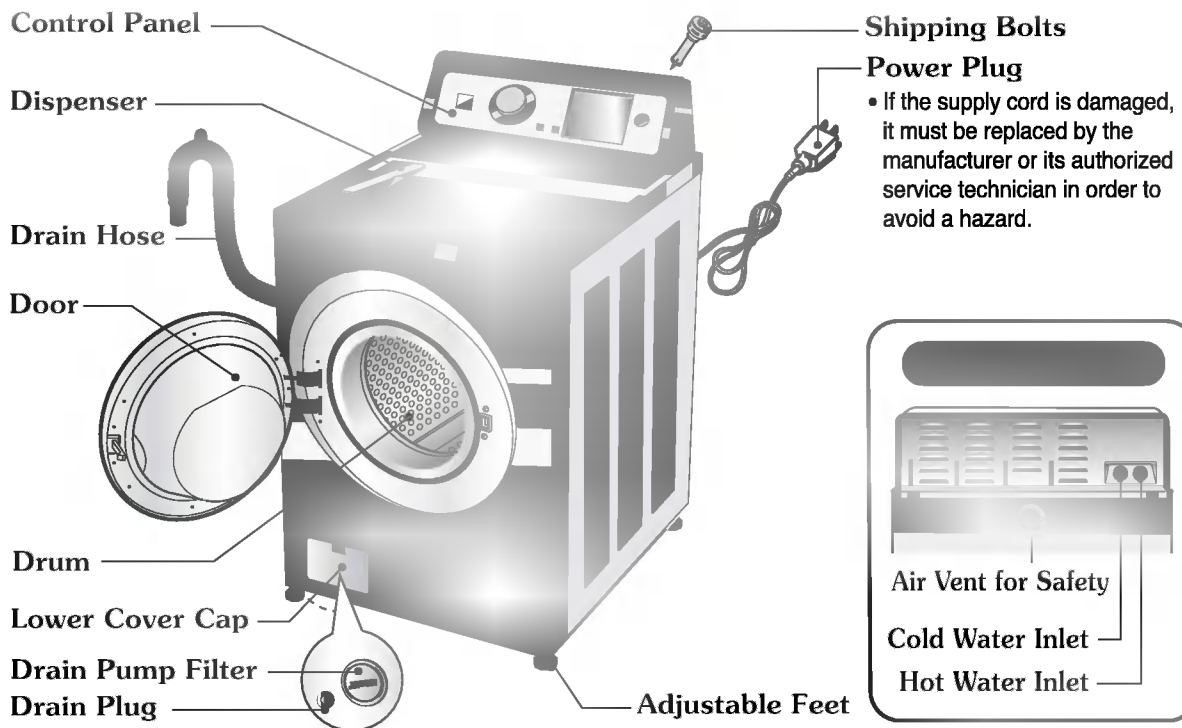

- ⌘ Name : Front-loading Washing Machine
- ⌘ Power supply : 240V~, 50Hz
- ⌘ Size : 68.6cm(W) X 75.0cm(D) X 108.6cm(H), 126.5cm(D, door open)
- ⌘ Weight : 86 kg
- ⌘ Wash capacity : 10 kg
- ⌘ Spin speed : No Spin/400/600/800/1000/1200 rpm (WD-1219BD)
No Spin/400/600/800/1000 rpm (WD-1019BD)
- ⌘ Permissible water pressure: 4.5 ~ 145 PSI (30 ~ 1000 kPa)
- ⌘ The external hot water supply 60°C and must NOT be above 70°C
- ⌘ Permissible cold water temperature : 4-25°C
- ⌘ TT : Appliance co.y with the requirement by certification Type Test Mark.
- ⌘ No further backflow protection required for connection to the water supply.
- * The appearance and specifications may be varied without notice to raise the units quality.

fR Specifications subject to change by manufacturer.

⌘ Accessories

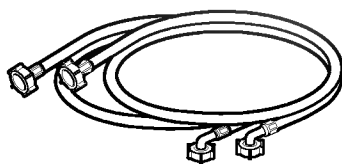

Hot/Cold (1 each)
Hose

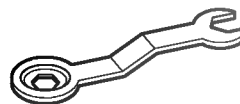

Wrench

Install or store unit where it will not be exposed to temperatures below freezing or exposed to outside weather conditions.

Properly ground washer to conform with all governing codes and ordinances.

The base opening must not be obstructed by carpeting when the washing machine is installed on a carpeted floor.

In countries where there are areas which may be subject to infestation by cockroaches or other vermin, pay particular attention to keeping the appliance and its surroundings in clean condition at all times.

Any damage which may be caused by cockroaches or other vermin will not be covered by the appliance guarantee.

⚠ Shipping bolts

The appliance is fitted with shipping bolts to prevent internal damage during transport.

⚠ Removing shipping bolts

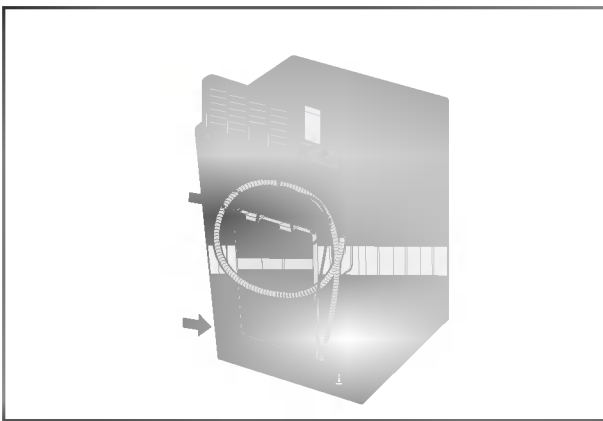

1. To prevent internal damage during transport, the special 4 bolts are locked. Before operating the washer, remove the bolts and braces.

- If they are not removed, it may cause heavy vibration, noise, and malfunction.

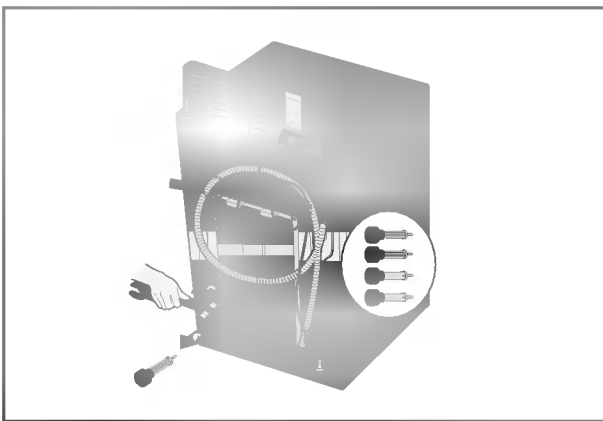

2. Unscrew the 4 bolts with the wrench supplied.

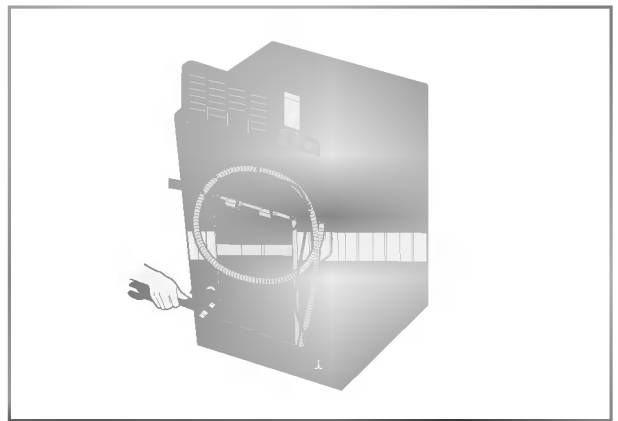

3. Take out the 4 bolts and braces by twisting the braces slightly. Keep the 4 bolts, braces and the wrench for future use.

- Whenever the appliance is transported, the shipping bolts and braces must be replaced.

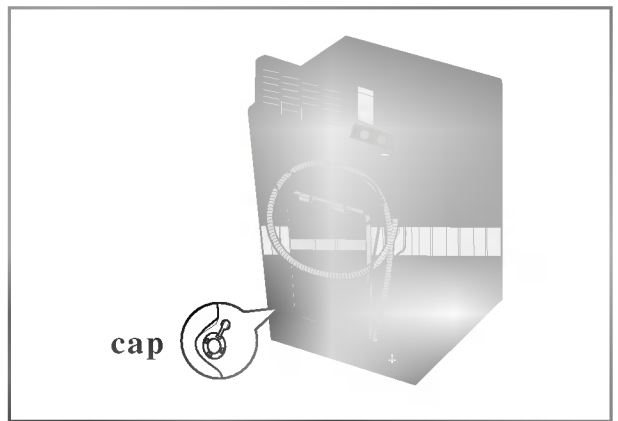

4. Close the holes with the caps supplied.

⚠ **Installation clearances**

The location must be large enough to fully open the washer door.

⚠ **Washer dimensions**

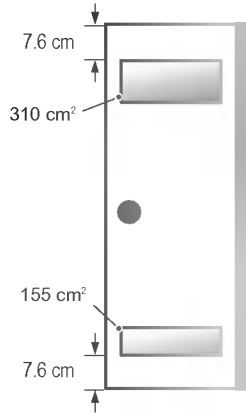
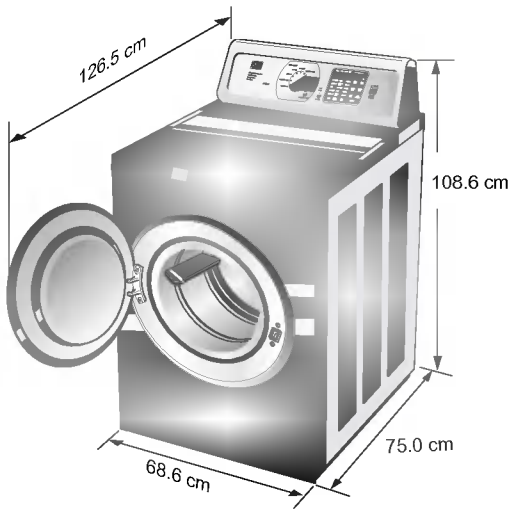

[Closet door with vents]

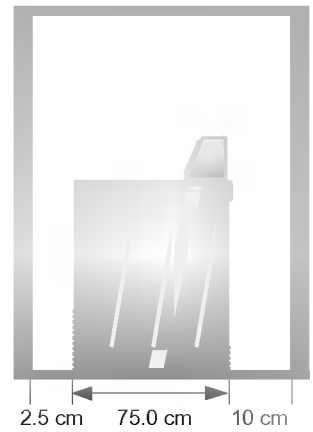

[Side view]

- Most installations require a minimum 10 cm clearance behind the washer.

⚠ **Minimum installation spacing for recessed area or closet installation**

The following dimensions shown are for the minimum spacing allowed.

Additional spacing should be considered for installation and servicing.

- Additional clearances might be required for wall, door and floor moldings.
- Additional spacing of 2.5 cm on all sides of the washer is recommended to reduce noise transfer.
- For closet installation, with a door, minimum ventilation openings in the top and bottom of the door are required. Louvered doors with equivalent ventilation openings are acceptable.

Companion appliance spacing should also be considered.

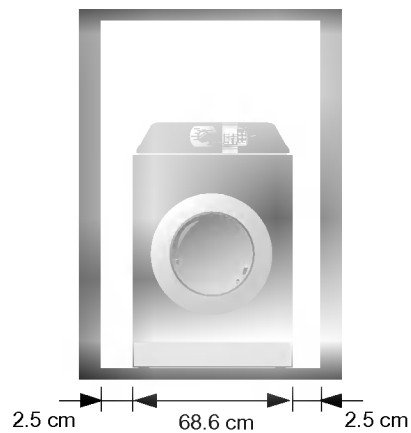

[Front view]

⚠ **Level floor**

Allowable slope under entire washer is 1°.

⚠ **Power outlet**

Must be within 1.5m of either side of the washer. Do not overload the outlet with more than one appliance.

⚠️ Electrical connection

- Do not use an extension cord or double adapter.
- If the supply cord is damaged, it must be replaced by the manufacturer or its authorized service technician in order to avoid a hazard.
- Always unplug the machine and turn off the water supply after use.
- Connect the machine to a grounded socket in accordance with current wiring regulations.
- The appliance must be positioned so that the plug is easily accessible.

⚠️ Connecting water supply hose

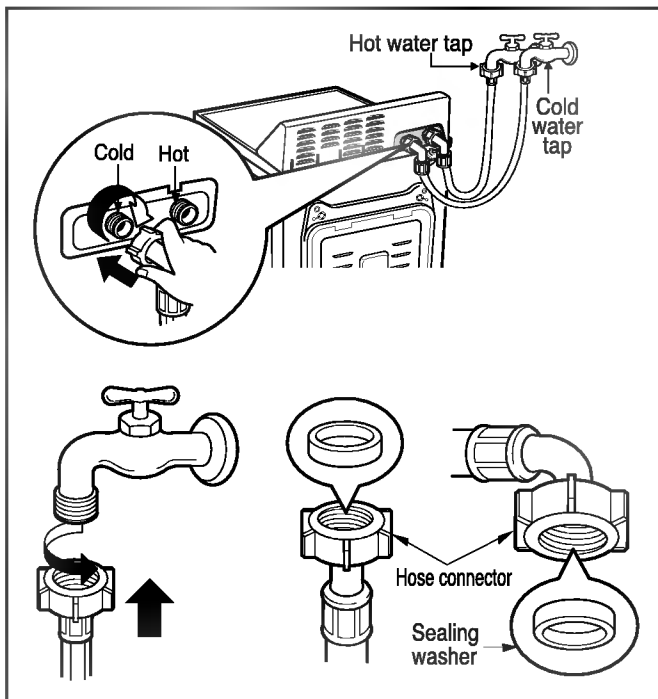

- Water supply pressure must be between 4.5 ~ 145 PSI (30~1000 kPa)
- Don't strip or crossthread when connecting Inlet hose to the valve.
- If the water supply pressure is more than 1000 kPa, a pressure reducer device should be installed.
- Two Sealing washers are supplied with the water inlet hoses to prevent water leaks.
- Check water tightness of washing machine connections by turning the tap completely on.
- Periodically check the condition of the hose and replace the hose if necessary.
- Make sure that there is no bent in the hose and that it is not crushed.
- The Inlet hose which has red connector is for the hot water tap.
- Hot and cold water faucets MUST be installed properly to your washer's water inlet.

NOTE : Washing Machine is to be connected to the water mains using new hoses.
Old hoses should not be used.

Repairs to the washing machine must only be carried out qualified personnel. Repairs carried out by inexperienced persons may cause injury or serious malfunctioning. Contact your local service center.

Do not install your washing machine in rooms where temperatures below freezing may occur. Frozen hoses may burst under pressure. The reliability of the electronic control unit may be impaired at temperatures below the freezing point.

If the appliance is delivered in the winter months and temperatures are below freezing. Store the washing machine at room temperature for a few hours before putting it into operation.

Installation of drain hose

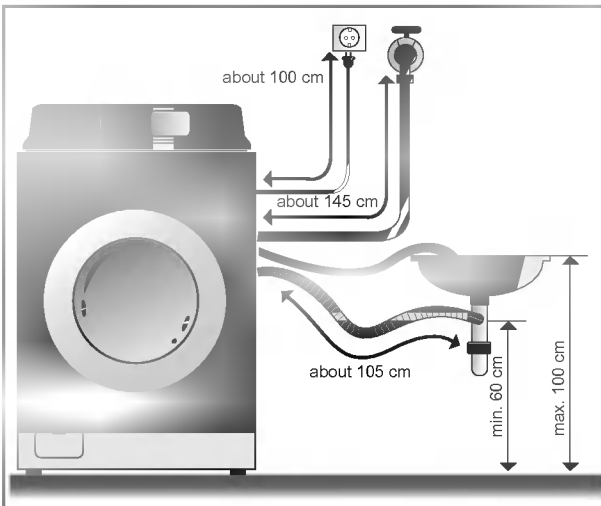
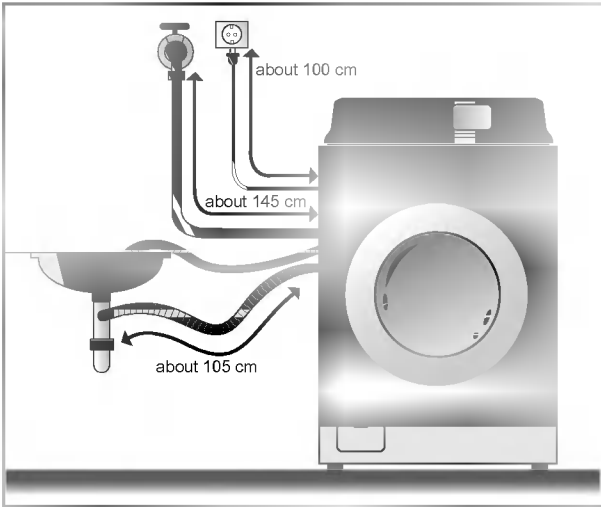

- The drain hose should not be placed higher than 100 cm. from the bottom of the washer.
- Properly securing the drain hose will protect the floor from damage due to water leakage.

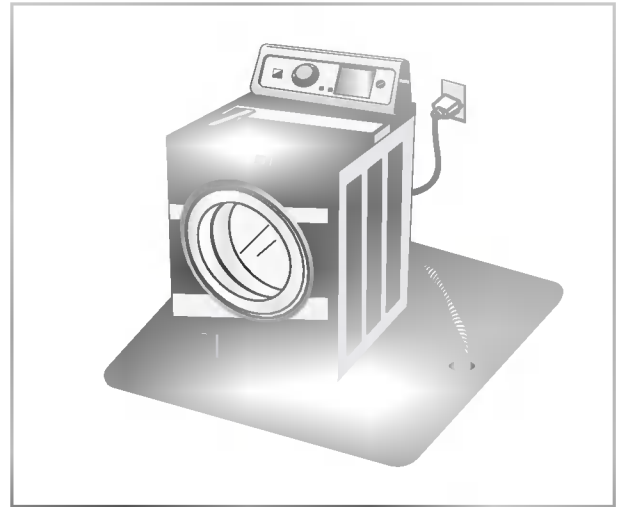

- This washer has a siphon break.
- Place the end of the drain hose in the hole of the floor drain system.

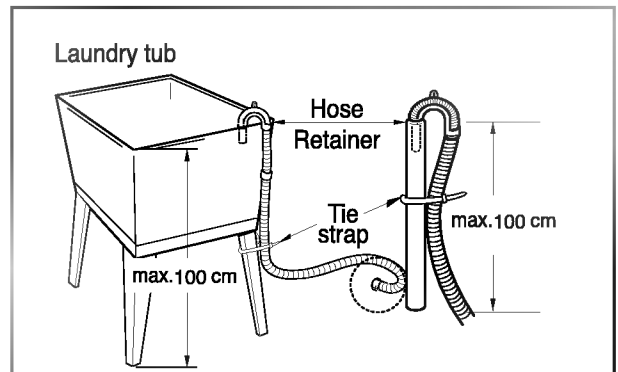

- When installing the drain hose at a sink, secure it so it cannot break away and cause flooding and damage.
- Properly securing the drain hose will protect the floor from damage due to water leakage.

This equipment is not designed for maritime use or for mobile installations such as in RV's, aircraft, etc. Turn off the valve if the machine is to be left for any length of time (e.g. holiday), especially if there is no floor drain (gully) in the immediate vicinity.

When disposing of the appliance, cut off the power cable, and destroy the plug.

Disable the door lock to prevent young children being trapped inside.

Packaging material (e.g. Films, Styrofoam) can be dangerous for children. There is a risk of suffocation! Keep all packaging from children.

⚙️ Level adjustment

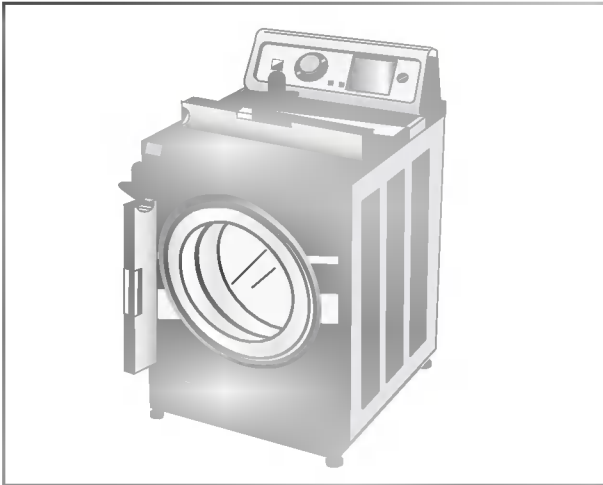

- Leveling the washing machine properly prevents excessive noise and vibration. Install the appliance on a solid and level floor surface, preferably in a corner of the room.

NOTE : Timber or suspended type flooring may contribute to excessive vibration and unbalance errors.

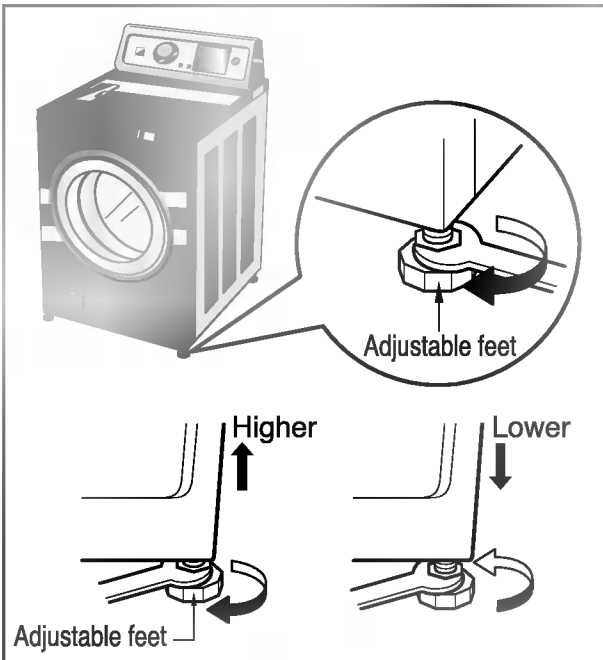

- If the floor is uneven, adjust the adjustable feet as required. (Do not insert pieces of wood, etc. under the feet.)
- Make sure that all four feet are stable and resting on the floor and then check that the appliance is perfectly level. (Use a leveling tool.)



fR Diagonal Check

When pushing down the edges of the washing machine top plate diagonally, the machine should not move up and down at all. (Please, check both directions.)

If machine rocks when pushing the machine top plate diagonally, adjust the feet again.

Do not use stain removal sprays near the machine as the overspray may fade or remove the printing from the front panel.



To reduce the risk of fire, electric shock, or injury to persons, read the IMPORTANT SAFETY INSTRUCTIONS before operating this appliance.

1. Fabric Care Labels

Look for a care label on your clothes. This will tell you about the fabric content of your garment and how it should be washed.

2. Sorting

To get the best results, sort clothes into loads that can be washed with the same wash cycle.

Different fabrics need to be washed in different ways.

Always sort dark colors from pale colors and whites. Wash separately as dye and lint transfer can occur causing discoloration of white clothing. If possible, do not wash heavily soiled items with lightly soiled ones.

Soil (Heavy, Normal, Light)

Color (White, Lights, Darks)

Lint (Lint Producers, Collectors)

Separate clothes according to amount of soil.

Separate white fabrics from colored fabrics.

Wash lint producers and lint collectors separately.

3. Check before loading

Combine large and small items in a load. Load large items first.

Large items should not be more than half the total wash load.

Do not wash single items. This may cause an out-of-balance load. Add one or two similar items.

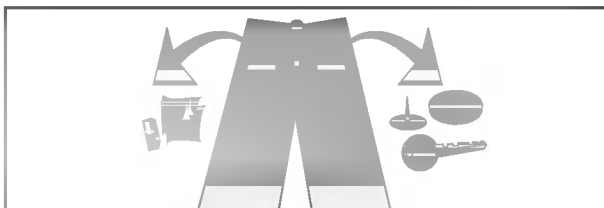

- Check all the pockets to make sure that they are empty. Things such as clip, matches, pens, coins, and keys can damage both your washer and your clothes.

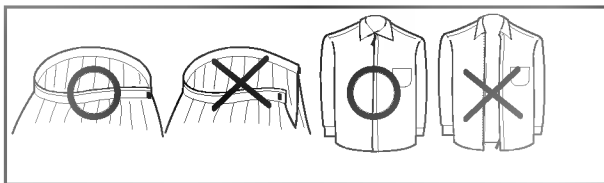

- Close zippers, hooks, and strings to make sure that these items do not snag on other clothes.

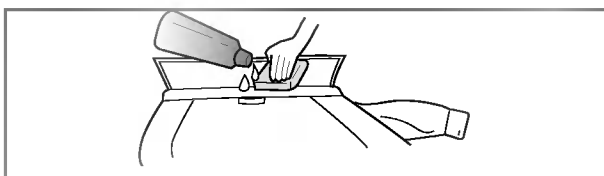

- Pretreat dirt and stains by brushing a little detergent dissolved in water onto stains like collars and cuffs to help lift dirt.

The automatic dispenser consists of three compartments which hold 1) liquid fabric softener, 2) liquid or powdered detergent for prewash and 3) liquid or powdered detergent and color safe bleach for main wash.

All laundry products can be added at once in their respective dispenser compartments.

They will be dispensed at the appropriate time for most effective cleaning. After loading the laundry additives into the dispenser, close the dispenser lid.

Add detergent, bleach and fabric softener to the automatic dispenser following these steps:

1. Open the dispenser lid.
2. Load the laundry products into the appropriate compartments.
3. Close the dispenser lid.

⚠ About detergent

Low lathering detergent is recommended for this washer. Use the manufacturer's recommended amount.

If low lathering detergent is not available, a reduced amount of regular detergent may be used.

Because reducing the amount of detergent may reduce cleaning, it is important to pretreat stains, sort carefully by color and soil level, and avoid overloading.

Detergent usage may need to be adjusted for water temperature, water hardness, size and soil level of the load.

For best results, avoid using too much detergent.

NOTE : Liquid detergent will drain into the washer drum as it is added.

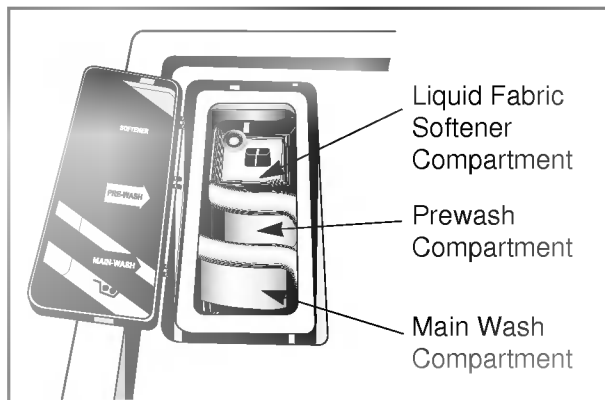

1. Fabric Softener Compartment

- Add recommended amount of fabric softener to this compartment.
- Dilute concentrated softeners with warm water to the fill line.
- Do not exceed the maximum fill line. Overfilling can cause early dispensing of the fabric softener which could result in stained clothes.
- Do not pour fabric softener directly on the wash load.
- The fabric softener will be automatically dispensed during the last rinse cycle.

2. Prewash Detergent Compartment

- Add detergent to this compartment when using the Prewash option. Liquid or powdered detergent may be used in this compartment. The detergent will automatically be dispensed during Prewash if the Prewash option is selected.
- Add 1/2 the recommended amount of detergent to the Prewash compartment and the recommended amount of detergent to the main wash compartment.

NOTE : If using pre-wash stain removers do not use on or near the Washer as they may cause damage to the control panel's finish.

3. Main Wash Detergent Compartment

- Add measured detergent to this compartment for Main wash. Detergent is flushed from the dispenser at the beginning of the cycle. Either powdered or liquid detergent can be used.
- Liquid or powdered color-safe bleach may be added to the main wash compartment along with the same type of detergent, liquid or powdered.

NOTE : If you are using the Prewash option with Main wash, powdered detergent must be used in the main wash compartment since liquid detergent will drain into the washer drum as it is added.

ⓘ Select cycles designed for different types of fabric and soil levels.

Program	Fabric Type	Proper Temp.	Option	Maximum Load	Time in Minutes
Cotton	First check if laundry is machine washable. (white cotton, linen towel and sheets...)	95°C	Pre Wash Time Delay Eco Bio Time Save Crease Care	Rating	155 (159)
	Color fast garments (shirts, night dresses, pajamas...)and lightly soiled white cotton(underwear...)	60°C (50°C, Cold, 40°C, 30°C)			151 (155)
Synthetic	Polyamide, Acrylic, Polyester	40°C (60°C, Cold, 50°C, 30°C)	Pre Wash Time Delay Eco Bio Time Save Crease Care	Less than 5.0 kg	82 (84)
Delicate	Delicate laundry easily damaged (silk, curtains...)	30°C (40°C, Cold)	Time Delay Time Save Crease Care	Less than 4.0 kg	64
Wool/Silk	Machine washable woolens with pure new wool only	30°C (40°C, Cold)	Time Delay Time Save Crease Care	Less than 3.0 kg	61 (63)
Hand Wash	"Hand Wash" marked delicate and wool laundry	Cold(30°C, 40°C)	Time Delay Time Save Crease Care	Less than 3.0 kg	52 (54)
Quick 30	Colored Laundry which is lightly soiled fast	30°C(40°C, Cold)	Time Delay Crease Care	Less than 5.0 kg	30



- Rotate the **Cycle selector knob** to select cycle designed for different types of fabric and soil levels.
- Each cycle has a preset Water Temperature, Spin, Rinse, Option.

See the page 13.

- The preset settings can be changed anytime before Start.



- Favorite Program allows you to store a customized wash cycle for future use.
- **To make a Favorite Program:**
 1. Select a cycle.
 2. Select the other desired **Water Temp., Rinse, Spin.**
 3. Select the desired Options.
 4. Press and hold Favorite Program button 3 seconds (2 beep sounds).
 5. Press **Start/Pause.**
The Favorite program is now stored for future use. To reuse the program, select Favorite Program and press **Start/Pause.**



- Choose **High / Low / Off.**

SPIN

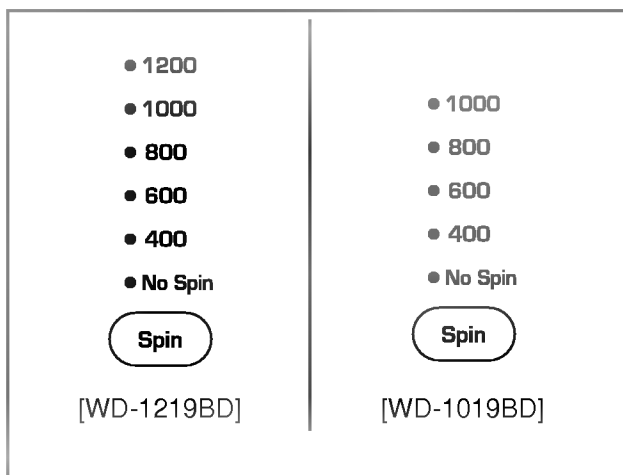

- By pressing the Spin button, the spin speed can be chosen.

1. Spin selection

- Spin speed is available according to the program as follows.

- **WD-1019BD**

- **Cotton & Quick 30 & Synthetic & Wool/Silk & Hand Wash**

- No Spin —400 —600 —800 —1000

- **Delicate**

- No Spin —400 —600 —800

- **WD-1219BD**

- **Cotton & Quick 30**

- No Spin —400 —600 —800 —1000 —1200

- **Synthetic & Wool/Silk & Hand Wash**

- No Spin —400 —600 —800 —1000

- **Delicate**

- No Spin —400 —600 —800

2. No spin

- If no spin is selected, the washer stops after draining water.

The required lamp will light up for identification.

WATER TEMP.

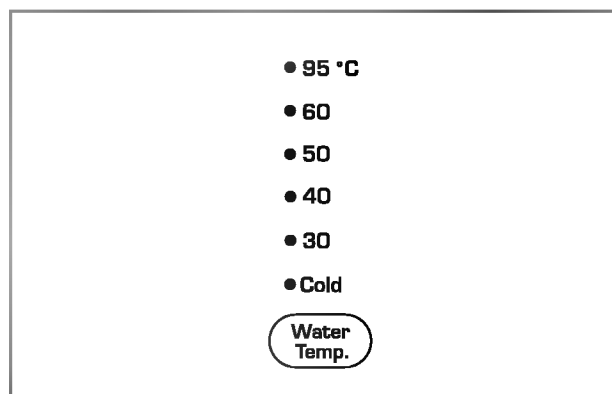

- By pressing the **Water Temp.** button, the water temperature can be selected.

- *Cold*

- *30°C / 40°C / 50°C / 60°C / 95°C*

1. Water Temperature

- Water temperature can be selected as below according to the program.

- **Cotton**

- Cold —30°C —40°C —50°C —60°C —95°C

- **Synthetic**

- Cold —30°C —40°C —50°C —60°C

- **Delicate & Wool / Silk & Quick 30 & Hand Wash**

- Cold —30°C —40°C

The required temperature lamp will light up for identification.

For the more detailed information, please refer to the page13.



1. Child Lock

- Child Lock can be set by pressing and holding the **Time Save** button and **Crease Care** button simultaneously.

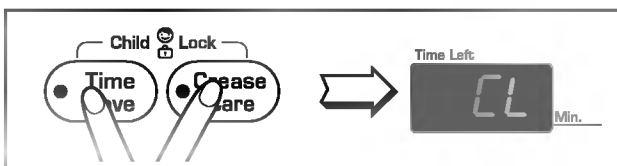

- When child lock is set, all buttons are inoperable.
- To deactivate Child Lock system, press and hold the **Time Save** and **Crease Care** button simultaneously again.



- To change to the desired program, whilst in child lock mode.

1. Press and hold both **Time Save** and **Crease Care** together once again.
2. Press the **Start/Pause** button.
3. Select the desired program and press the **Start/Pause** button again.

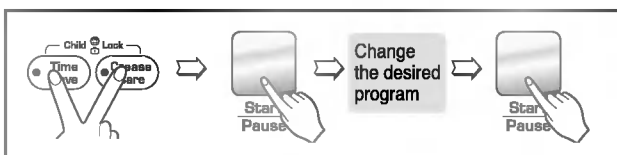

- The child lock can be set at any time and it is automatically canceled when operational errors occur. Also **Child Lock** works when power is off.



- 9 programs are available according to the laundry type.
- Lamp will light up to indicate selected program.

1. Program

- When **Start/Pause** button is pressed, the Cotton program is automatically selected.
- By turning the Program dial, the program is selected in order of "Cotton – Synthetic – Delicate – Wool/Silk – Hand Wash – Quick 30 – Rinse+Spin – Spin – Drain".

Regarding to the laundry type for each program Please refer to the page 13.

2. Course

- | | | |
|---------------|--------------|---------|
| - Cotton | - Hand Wash | - Drain |
| - Synthetic | - Quick 30 | |
| - Delicate | - Rinse+Spin | |
| - Wool / Silk | - Spin | |

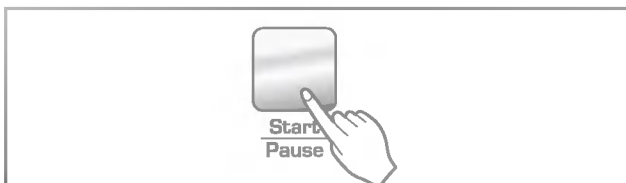

1. Start



- This **Start/Pause** button is used to start wash cycle or pause the wash cycle.

2. Pause

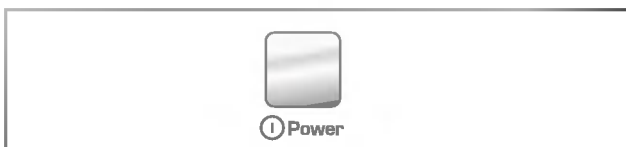
- If temporary stop of wash cycle is needed, press the **Start/Pause** button.
- When in Pause, the power is turned off automatically after 4 minutes.
- **NB.** The door will not open before 1 to 2 minutes when Pause is selected, or at the end of the wash cycle.



1. Power

- Press the **Power**() button to turn power on and off
- To cancel the **Time Delay** function, the **Power**() button should be pressed.

2. Initial Program

- When the **Power**() button is pressed, the washer is ready for Coloureds program. And the other initial conditions as follows.
- So, if you want to advance into the washing cycle without changing the program, just press the **Start/Pause** button and then the washer will proceed.



1. Special function display

- When child lock is selected, the "CL" is displayed.
- When time delay is selected, it shows the remaining times to finish the selected program.

2. Self diagnose display

- If the washer encounters a fault during operation, the associated fault will be displayed.
 - "PE" : Water pressure sensing error
 - "FE" : Problem of overfilling water
 - "dE" : Door is not closed
 - "LE" : Over load in moter.
 - "EE" : Over load in moter.
 - "IE" : Water inlet trouble
 - "DE" : Drainage trouble
 - "UE" : Unbalanced load
 - "tE" : Water temperature trouble

If these error letters are displayed, please refer to the troubleshooting page24 and follow the guide.

3. Completion of washing

- When washing cycle is completed, "End" is displayed on the "Multi display".

4. Time left

- During washing cycle, the remaining washing time is displayed.
- Recommended program by manufacturer.
 - Cotton 95°C : around 2 hour and 35(39) minutes
 - Cotton 60°C : around 2 hour and 31(35) minutes
 - Synthetic : around 1 hour and 22(24) minutes
 - Delicate : around 1 hour and 4 minutes
 - Wool / Silk : around 1 hour and 1(3) minutes
 - Hand Wash : around 52(54) minutes
 - Quick 30 : around 30 minutes
 - Rinse+ Spin : around 17(21) minutes
 - Spin : around 11(15) minutes
 - Drain : around 1 minute
- The washing time may vary by the amount of laundry, water pressure, water temperature and other washing conditions.
- If an unbalanced load is detected or if the suds removing program operates, the wash time may be extended.
(Max. increasing time is 45minutes.)

OPTION

1. Prewash

- Use this option for loads that need pretreatment. Adds 16 minutes prewash and drain.
- **When using Prewash option, do not use liquid detergent in the Main Wash Compartment. Use powdered for the main wash.**

2. Eco

- By selecting Eco function, the water temperature is reduced and washing time is lengthened. So you can economize in your consumption of heating energy.
- NB.** You can select Eco function when temperature is higher than 60°C in Cotton and Synthetic.

3. Time Save

- This option can be used to reduce the time of a wash program.
- To use this option press the Time Save button once before the wash program is started.
- This option is not available with Quick 30 program.

4. Time Delay

Preparing washing before starting “Time Delay”

- Turn on the water tap.
- Load laundry and close the door.
- Place the detergent and fabric softener in the drawer.

• How to set “Time Delay”

- Press Power button.
- Press the Program button to select the program you require.
- Press Time Delay button and set the desired time.
- Press the Start/Pause button.

(“:” blinks.)

- If Time Delay button is pressed, “3:00” is displayed. The maximum delayed time is 19:00 hours and the minimum time is 3:00 hours.
- Each pressing of the button advances on time delay by one hour.
- To cancel the time delay, press the Power button.
- Time Delay is ‘estimated time’ from the present to the completion of washing cycle or selected process.
- According to the condition of water supply and temperature, the delayed time and the actual washing time may vary.

5. Bio

- If you want to eliminate protein stains(milk, blood, chocolate...), you may select Bio function by pressing the option button.

NB. You can select Bio function when temperature is higher than 60° C in Cotton and Synthetic.

6. Crease Care

- If you want to prevent crease, select this button with spin.

DOOR LOCKED

- Lights whenever the door of the washer is locked.
- The door can be unlocked by pressing the **Start/Pause** button to stop the washer.
- The door can be opened after a short delay.

STATUS INDICATOR

- These lights show elapsed time of the cycle the washer is operating.

MAINTENANCE

Before cleaning the washer interior, unplug the electrical power cord to avoid electrical shock hazards. When disposing of the appliance, cut off the power cable, destroy the plug, and disable the door lock to prevent young children from being trapped inside.

⚠ The water inlet filter

- "iE" error message will blink on the control panel when water does not enter the dispenser.
- If your water is very hard or contains traces of lime deposit, the water inlet filter may become clogged. We recommend cleaning it every few months.

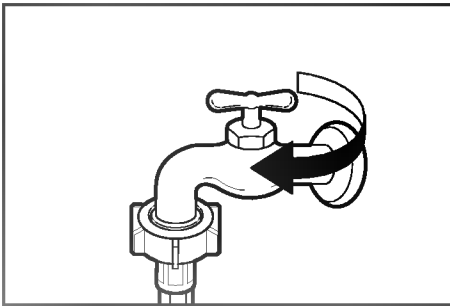

1. Turn off the water tap.

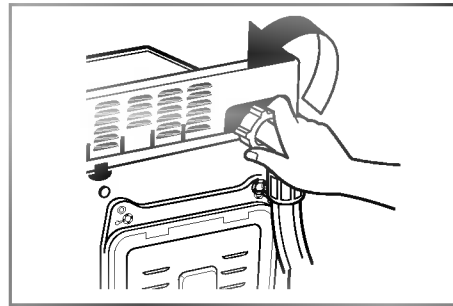

2. Unscrew the water inlet hose.

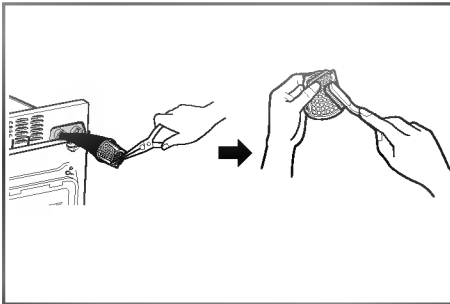

3. Clean the filter using a hard bristle brush.

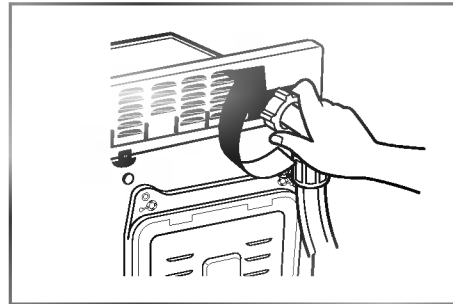

4. Tighten up the inlet hose.

⚠ The drain pump filter

- The drain filter collects threads and small objects left in the laundry. Check regularly that the filter is clean to ensure smooth running of your machine.



First drain using the drain hose and then open the pump filter to remove objects. Be careful when draining if the water is hot.

- Allow the water to cool down before cleaning the drain pump filter.

1. Open the lower cover cap (①). Turn the drain plug (②) to pull out the hose.

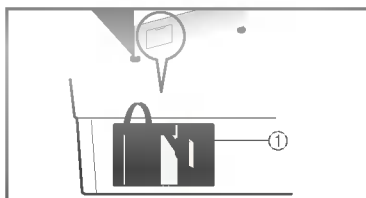

2. Unplug the drain plug (②), allowing the water to flow out. At this time use a vessel to prevent water from flowing onto the floor. When water does not flow any more, turn the pump filter (③) open to the left.

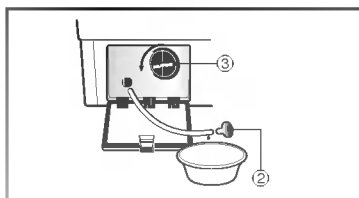

3. Remove out any foreign objects from the pump filter (③). After cleaning, turn the pump filter (③) clockwise and insert the drain plug (②) to the original place. Close the lower cover cap (①).

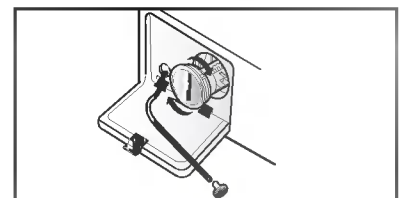

MAINTENANCE

⚠️ Cleaning the Dispenser

- The dispenser may need to be cleaned periodically due to laundry additive build-up.

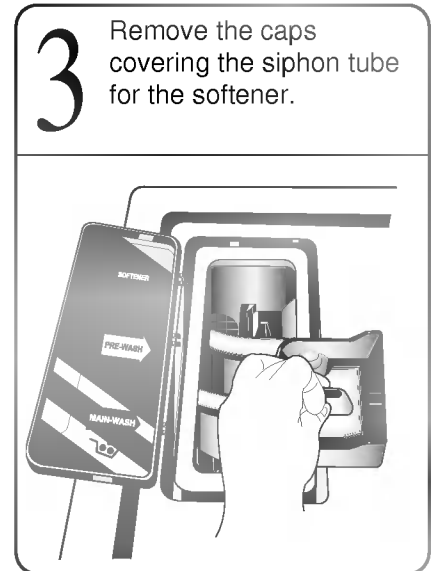
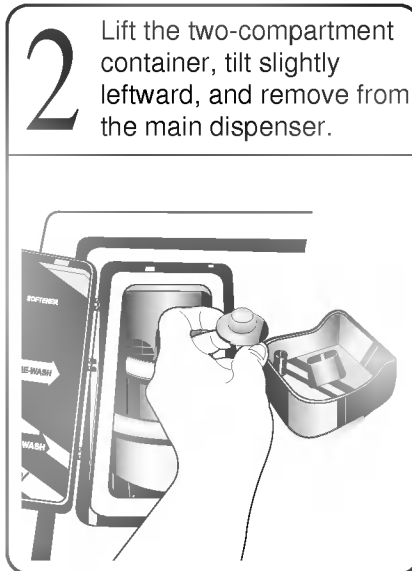
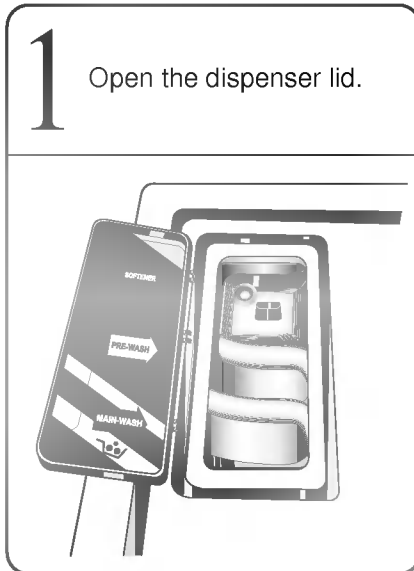

- Once the two-compartment container is removed from the main dispenser, take it to a sink. Run warm water and a soft brush or cloth over the two parts to remove any excess laundry additives.
- Clean the main dispenser area using water and a soft cloth. Once the main dispenser is clean, follow the illustrations in reverse order to replace the two compartment container to its original location.

NOTE : Do not use any cleaning substance on the main dispenser but water. It is possible for cleaning substances to drain into the tub. If this should happen, set the washer for a rinse and spin cycle to remove any cleaning substance from the washer before doing a load of laundry.

⚠️ The washing drum

- If you live in a hard water area, limescale can continuously build up in places where it cannot be seen and it is not easily removed from the drum. Over time the build-up of scale clogs appliances, and if it is not kept in check, these will eventually have to be replaced.
- Although the washing drum is made of Stainless steel, specks of rust can be caused by small metal articles (paper clips, safety pins, etc.) which have been left in the drum.
- The washing drum should be cleaned from time to time.
- If you use descaling agents, dyes, or bleaches, make sure they are suitable for washing machine use.
- Descaler could contain components that can damage part of your washing machine.
- Remove the spots with a stainless steel cleaning agent.
- Never use steel wool.

MAINTENANCE

ⓘ Cleaning your washer

1. Exterior

Proper care of your washer can extend its life.

The outside of the machine can be cleaned with warm water and a neutral, non-abrasive household detergent.

Immediately wipe off any spills. Wipe with a damp cloth.

Try not to damage the surface with sharp objects.

ⓘ **IMPORTANT:** Do not use methylated spirit, solvents or similar products.

2. Interior

Dry around the washer door opening, flexible gasket and door glass. These areas should always be clean to ensure a water-tight seal.

Run washer through a complete cycle using hot water.

Repeat process if necessary.

NOTE : Remove hard water deposits using only cleaners labeled as safe for washing machines.

ⓘ Winterizing instructions

If the washer is stored in an area where freezing can occur or moved in freezing temperatures, follow these winterizing instructions to prevent damage to the washer:

1. Turn off water supply tap.
2. Disconnect hoses from water supply and drain water from hoses.
3. Plug electrical cord into a properly grounded electrical outlet.
4. Add 1 gallon (3.8 ℓ) nontoxic recreational vehicle (RV) antifreeze to empty wash drum. Close door.
5. Set spin cycle and let washer spin for 1 minute to drain out all the water.
Not all of the RV antifreeze will be expelled.
6. Unplug electrical power cord, dry drum interior, and close door.
7. Remove the two-compartment container from the Dispenser. Drain any water in compartments and dry the compartments.
8. Store washer in an upright position.
9. To remove antifreeze from washer after storage, run empty washer through a complete cycle using detergent.
Do not add laundry.

TROUBLESHOOTING GUIDE

ⓘ This washing machine is equipped with automatic safety functions which detect and diagnose problems at an early stage and react appropriately. When the machine does not function properly or does not function at all, check the following points before you call the Service Department.

Problem	Possible Cause	Solution
Rattling and clanking noise	<ul style="list-style-type: none"> Foreign objects such as coins or safety pins may be in drum or pump. 	<p>Stop washer and check drum and drain filter.</p> <p>If noise continues after washer is restarted, call for service.</p>
Thumping sound	<ul style="list-style-type: none"> Heavy wash loads may produce a thumping sound. This is normal. 	<p>If sound continues, washer is probably out of balance. Stop and redistribute wash load.</p>
Vibrating noise	<ul style="list-style-type: none"> Have all the transit bolts and packing been removed? Wash load may be unevenly distributed in the drum. Are all the feet resting firmly on the ground? 	<p>See Installation Instructions for removing shipping bolts.</p> <p>Stop washer and rearrange wash load.</p> <p>Adjust the leveling feet.</p>
Water leaks	<ul style="list-style-type: none"> Fill hose connection is loose at tap or washer. House drain pipes are clogged. 	<p>Check and tighten hose connections.</p> <p>Unclog drain pipe. Contact plumber if necessary.</p>
Excessive lathering	<ul style="list-style-type: none"> Too much detergent or unsuitable detergent. 	<p>Reduce detergent amounts or use low sudsing detergent.</p>
Water does not enter washer or it enters slowly	<ul style="list-style-type: none"> Water supply is not adequate in area. Water supply tap is not completely open. Water inlet hose is bent. The filter of the inlet hose clogged. 	<p>Check another tap in the house.</p> <p>Fully open tap.</p> <p>Straighten hose.</p> <p>Check the filter of the inlet hose.</p>
Water in the washer does not drain or drains slowly	<ul style="list-style-type: none"> Drain hose is bent or clogged. The drain filter is clogged. 	<p>Clean and straighten the drain hose.</p> <p>Clean the drain filter.</p>

TROUBLESHOOTING GUIDE

Problem	Possible Cause	Solution
IE	<ul style="list-style-type: none"> • Water supply is not adequate in area. • Water supply taps are not completely open. • Water inlet hose is bent. • The filter of the inlet hose clogged. 	<p>Check another tap in the house.</p> <p>Fully open tap.</p> <p>Straighten hose.</p> <p>Check the filter of the inlet hose.</p>
DE	<ul style="list-style-type: none"> • Drain hose is bent or clogged. • The drain filter is clogged. 	<p>Clean and straighten the drain hose.</p> <p>Clean the drain filter.</p>
UE	<ul style="list-style-type: none"> • Load is too small. • Load is out of balance. • The appliance has an imbalance detection and correction system. If individual heavy articles are loaded (bath mat, bath robe, etc.) this system may stop spinning or even the spin cycle altogether if the imbalance is too great even after several spin starts. 	<p>Add 1 or 2 similar items to help balance the load.</p> <p>Rearrange load to allow proper spinning.</p>
dE	<ul style="list-style-type: none"> • Is the door opened or not completely closed? 	<p>Close the door completely.</p> <p>If dE is not released, call for service.</p>
tE		<p>Unplug the power plug and call for service.</p>
FE	<ul style="list-style-type: none"> • The water overfills due to the faulty water valve. 	<p>Close the water tap.</p> <p>Unplug the power plug.</p> <p>Call for service.</p>
PE	<ul style="list-style-type: none"> • The water level sensor malfunction. 	
CE	<ul style="list-style-type: none"> • Overload in motor. 	
LE	<ul style="list-style-type: none"> • Overload in motor. 	
PF	<ul style="list-style-type: none"> • The washer experienced a power failure. 	<p>Restart the cycle.</p>

LG WASHING MACHINE LIMITED WARRANTY-USA

What Is Not Covered:

- Service trips to your home to teach you how to use the product.
- If the product is connected to any voltage other than that shown on the rating plate.
- If the fault is caused by accident, neglect, misuse or Act of God.
- If the fault is caused by factors other than normal domestic use or use in accordance with the owner's manual.
- Provide instruction on use of product or change the set-up of the product.
- If the fault is caused by pests for example, rats or cockroaches etc..
- Noise or vibration that is considered normal for example water drain sound, spin sound, or warming beeps.
- Correcting the installation for example, levelling the product, adjustment of drain.
- Normal maintenance which recommended by the owner's manual.
- Removal of foreign objects / substances from the machine, including the pump and inlet hose filter for example, grit, nails, bra wires, buttons etc.
- Replace fuses in or correct house wiring or correct house plumbing.
- Correction of unauthorized repairs.
- Incidental or consequential damage to personal property caused by possible defects with this appliance.
- If this product is used for commercial purpose, it is not warranted.

(Example : Public places such as public bathroom, lodging house, training center, dormitory)

If the product is installed outside the normal service area, any cost of transportation involved in the repair of the product, or the replacement of a defective part, shall be borne by the owner.